

PL Instrukcja montażu

GB Assembly instructions

D Montageanleitung

FR Notice de montage

IT Istruzioni di montaggio

NL Montage-instructies

Nazwa /Name /Name /Nom /Nome /Namm

JARDIN 354

UWAGA /REMARQUE /NOTE /ATTENZIONE /HINWEIS /LETOP

PL Objętość wody w basenie 5.56 m³

FR Le volume de l'eau dans la piscine 5.56 m³

GB Water capacity in the pool 5.56 m³

IT Il volume di acqua in piscina 5.56 m³

D Volumen von Wasser im Schwimmbecken 5.56 m³

NL Water inhoud van het zwembad 5.56 m³

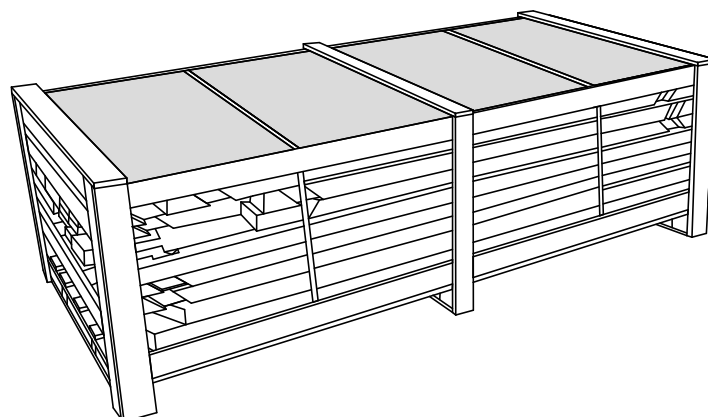
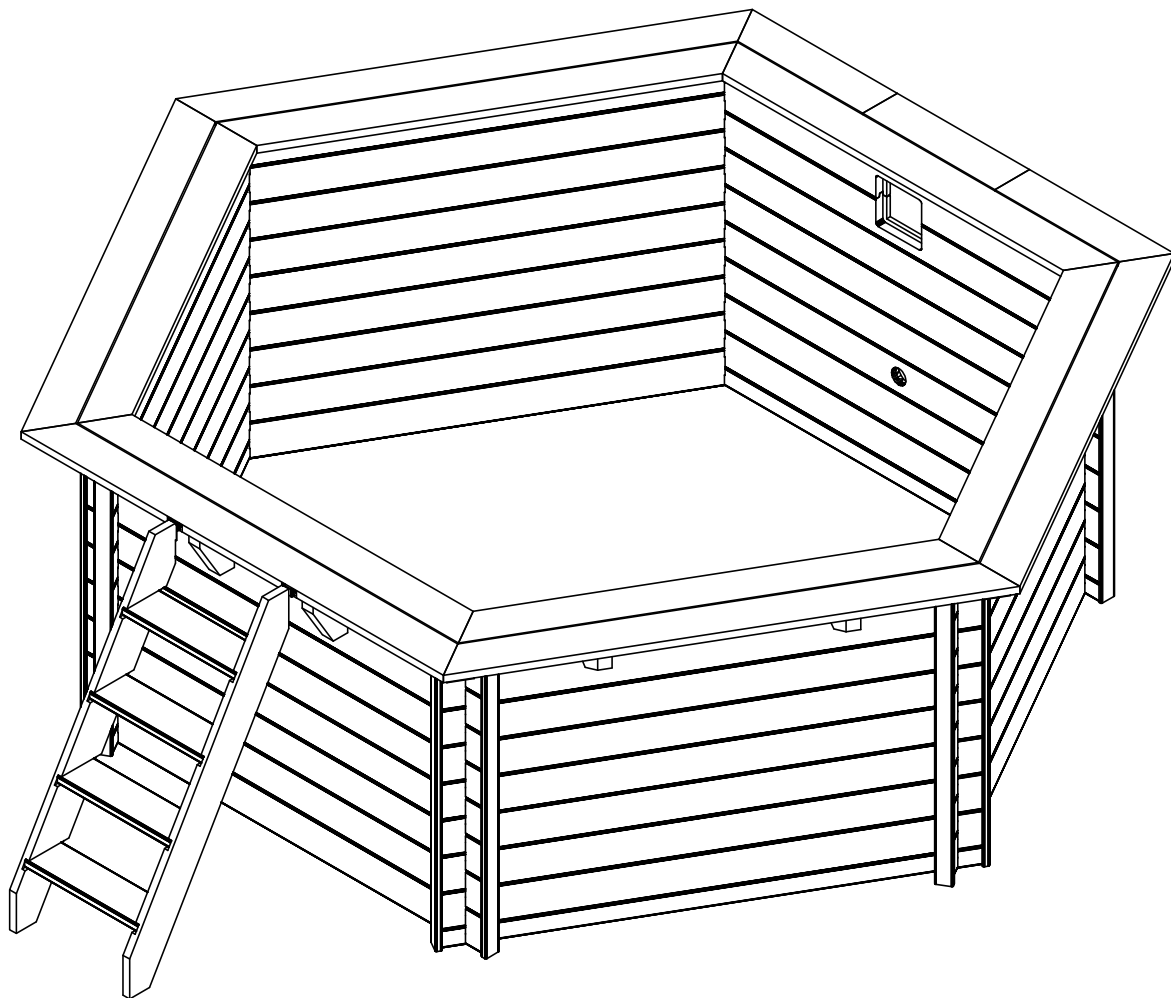

(PL) Instrukcja montażu

(GB) Assembly instructions

(DE) Montageanleitung

(FR) Notice de montage

(IT) Istruzioni di montaggio

(NL) Montage-instructies



(PL) Przed przystąpieniem do montażu zapoznaj się z instrukcją.

(FR) Avant le montage lisez attentivement la notice.

(GB) Read carefully pool installation manual before the installation.

(IT) Prima del montaggio é necessario consultare il manuale.

(DE) Lesen Sie das Pool-Installationshandbuch vor der Installation sorgfältig durch.

(NL) Lees zorgvuldig de handleiding van het zwembad voordat u met de installatie begint.

UWAGA / REMARQUE / NOTE / ATATTENZIONE / HINWEIS / OPMERKING

Instrukcja, którą posiadacie Państwo w ręku pokazuje krok po kroku w jaki sposób dokonać właściwego montażu basenu. Dołożyliśmy wszelkich starań, aby przygotować materiały jak najbardziej odzwierciedlające stan faktyczny i wygląd poszczególnych elementów. Jednak proszę pamiętać, że wszelkie rysunki mają charakter poglądowy i istnieje możliwość, że poszczególne elementy dostarczone w Państwa zestawie w rzeczywistości mogą odbiegać wyglądem od ich wizualizacji graficznej zawartej w instrukcji.

(PL)

Le manuel que vous avez entre les mains montre étape par étape comment assembler correctement la piscine. Nous avons fait tous les efforts pour préparer les documents reflétant autant que possible l'état réel et l'apparence des éléments particuliers. Pourtant, il faut savoir que tous les dessins sont présentés à titre de référence et qu'il est possible que les éléments singuliers fournis dans votre kit puissent différer en apparence de leur visualisation graphique incluse dans le manuel.

(FR)

This manual presents the correct assembly procedure for the swimming pool, step by step. We have undertaken all possible efforts to make sure that the materials are as close to the actual items and present their layout as closely as possible. Please remember, however, that all figures are indicative only and individual elements delivered in your set may be different than their graphical visualisations presented in the manual.

(GB)

Le presenti istruzioni spiegano passo dopo passo come montare correttamente la piscina. Abbiamo fatto del nostro meglio per preparare i materiali che rispecchiano il più fedelmente possibile lo stato reale e l'aspetto dei singoli elementi. Occorre però ricordare che le figure hanno carattere illustrativo ed è possibile che i singoli elementi forniti nel Vostro kit avranno l'aspetto diverso dalla loro visualizzazione grafica contenuta nelle istruzioni.

(IT)

Die Ihnen vorliegende Anleitung erläutert Ihnen Schritt für Schritt, wie das Schwimmbecken korrekt montiert wird. Wir haben alles daran gesetzt, die Unterlagen bestmöglich an den tatsächlichen Zustand und das Aussehen der einzelnen Teile anzupassen. Bitte bedenken Sie jedoch, dass alle Zeichnungen nur zu Anschauungszwecken dienen. Deshalb kann es sein, dass einzelne Teile in Ihrem Set anders aussehen, als in der graphischen Visualisierung in der Anleitung.

(DE)

Deze handleiding presenteert stap voor stap hoe u het zwembad op de juiste manier kunt monteren. We hebben er alles aan gedaan om een handleiding te maken die een realistisch beeld weergeeft van de montage en onderdelen.

(NL)

Houd echter wel rekening mee dat alle tekeningen alleen ter referentie dienen en dat het mogelijk is dat de afzonderlijke elementen in uw set kunnen afwijken van de grafische tekeningen in deze handleiding.

(PL) Instrukcja montażu

(GB) Assembly instructions

(DE) Montageanleitung

(FR) Notice de montage

(IT) Istruzioni di montaggio

(NL) Montage-instructies



(PL) Przed przystąpieniem do montażu zapoznaj się z instrukcją. * Bez wylewki betonowej.

(FR) Avant le montage lisez attentivement la notice. * Sans dalle de béton.

(GB) Read carefully pool installation manual before the installation. * Without concrete base.

(IT) Prima del montaggio è necessario consultare il manuale. * Senza una lastra di cemento.

(DE) Lesen Sie das Pool-Installationshandbuch vor der Installation sorgfältig durch. * Ohne Betonbasis.

(NL) Lees zorgvuldig de handleiding van het zwembad voordat u met de installatie begint. * Zonder betonnen basis.

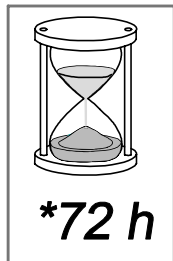

*72 h

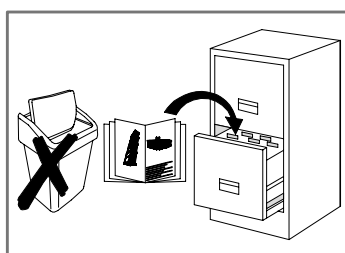
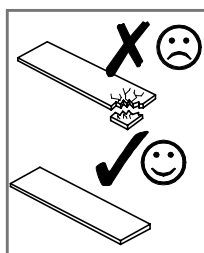
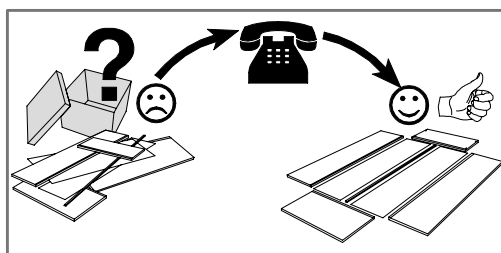
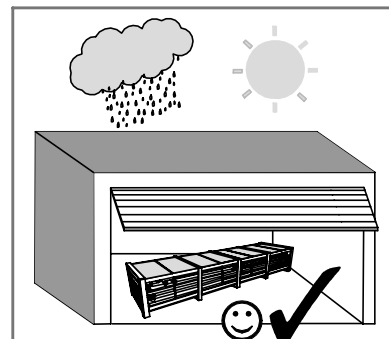
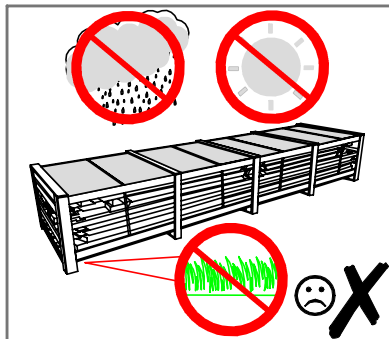
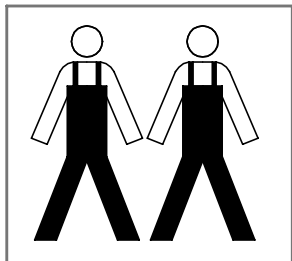

UWAGA / REMARQUE / NOTE / ATENZIONE / HINWEIS / OPMERKING

(PL) Montaż wykonać w przeciągu 3 dni od rozpakowania struktury.

(FR) Le montage de la structure doit être terminé dans un délai de 3 jours suivant l'ouverture de l'emballage.

(GB) Installation should be finished within 3 days from opening the package.

(IT) Il montaggio effettuare entro 3 giorni dal disimballo della struttura.

(DE) Die Installation sollte innerhalb von 3 Tagen nach dem Öffnen des Pakets abgeschlossen sein.

(NL) De installatie moet binnen 3 dagen na opening van het pakket worden voltooid.



UWAGA / REMARQUE / NOTE / ATENZIONE / HINWEIS / OPMERKING

(PL) Brak corocznej konserwacji struktury powoduje utratę gwarancji.

(FR) En cas de défaut d'entretien annuel de la structure, la garantie est invalidée.

(GB) Lack of once a year conservation of the structure causes loss of warranty.

(IT) Mancanza della manutenzione annuale causa la perdita di garanzia.

(DE) Der Mangel an einmal jährlichem Schutz der Struktur verursacht einen Garantieverlust.

(NL) Het uitblijven van onderhoud aan de constructie eenmaal per jaar zorgt voor verval van de garantie.



UWAGA / REMARQUE / NOTE / ATENZIONE / HINWEIS / OPMERKING

(PL) Nie pozostawiać dzieci bez nadzoru!

(FR) Ne laissez pas les enfants sans surveillance!

(GB) Do not leave children unattended!

(IT) Non lasciare bambini incustoditi!

(DE) Lassen Sie Kinder nicht unbeaufsichtigt!

(NL) Laat kinderen niet zonder toezicht!

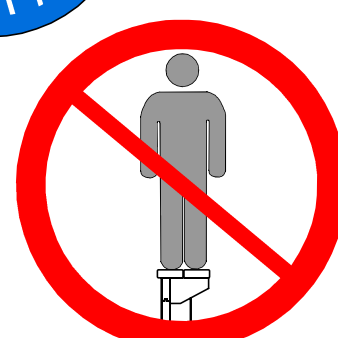
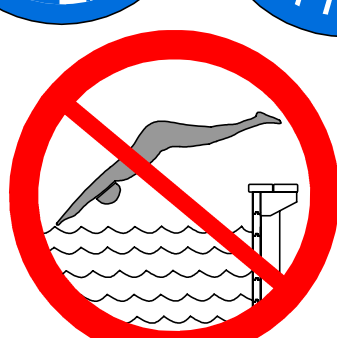

(PL) Elementy

(GB) Elements

(D) Elemente

(FR) Les éléments

(IT) Elementi

(NL) Balken



- (PL)** Sprawdź ilość oraz czy elementy nie są uszkodzone.
- (FR)** Vérifiez la quantité et si les éléments ne sont pas abîmés.
- (GB)** Check quantity of elements and if they are not faulty.
- (IT)** Controllare la quantità e se gli elementi non sono danneggiati.
- (D)** Überprüfen Sie die Menge, und ob die Elemente nicht beschädigt sind.
- (NL)** Controleer de aantal balken, en op eventuele beschadigingen.

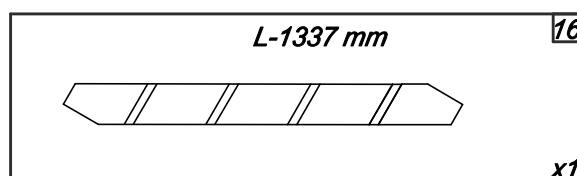
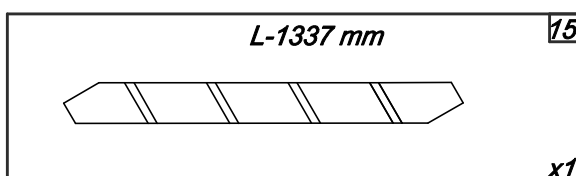
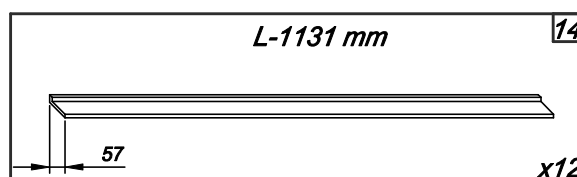
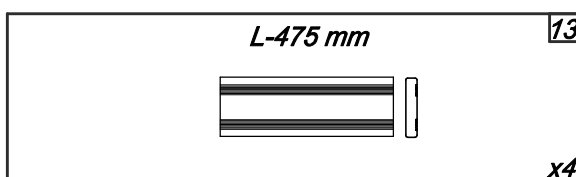
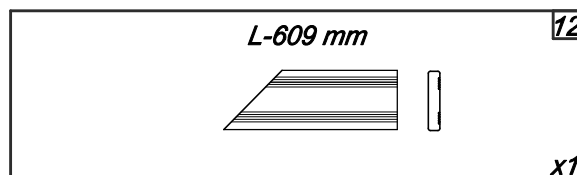
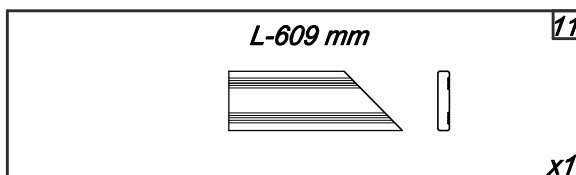
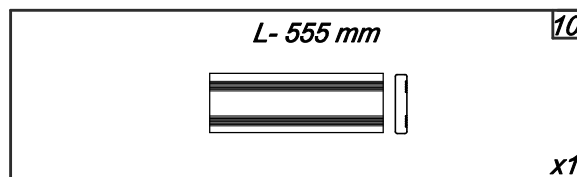
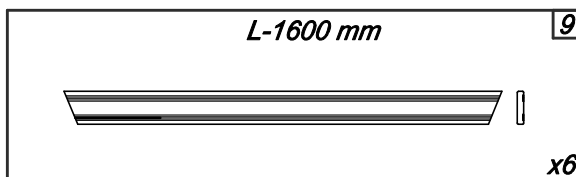
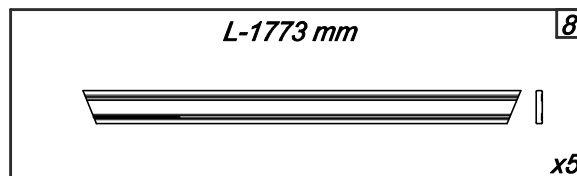
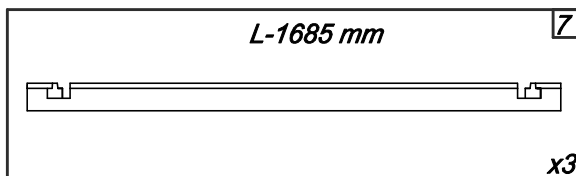
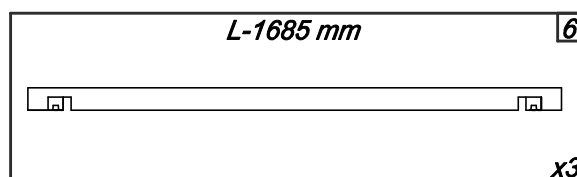
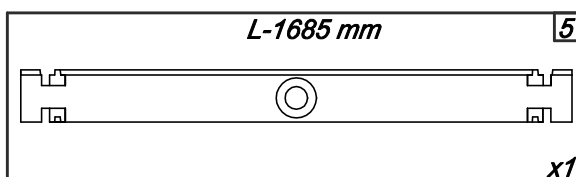
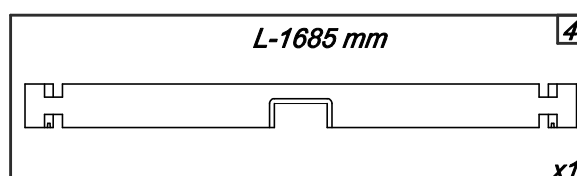
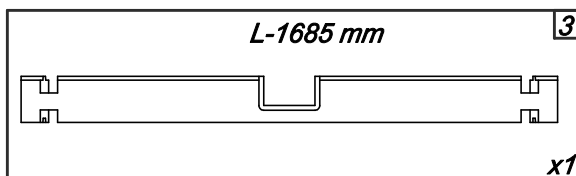
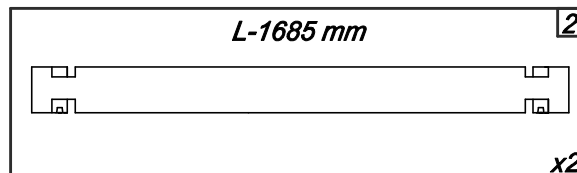
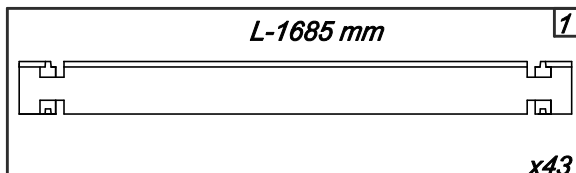
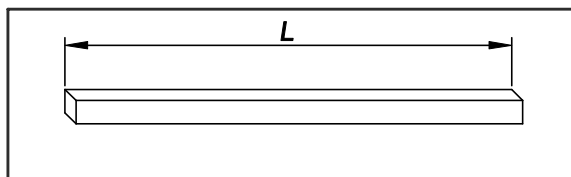

(PL) Elementy

(GB) Elements

(D) Elemente

(FR) Les éléments

(IT) Elementi

(NL) Balken



(PL) Sprawdź ilość oraz czy elementy nie są uszkodzone.

(FR) Vérifiez la quantité et si les éléments ne sont pas abîmés.

(GB) Check quantity of elements and if they are not faulty.

(IT) Controllare la quantità e se gli elementi non sono danneggiati.

(D) Überprüfen Sie die Menge, und ob die Elemente nicht beschädigt sind.

(NL) Controleer de aantal balken, en op eventuele beschadigingen.

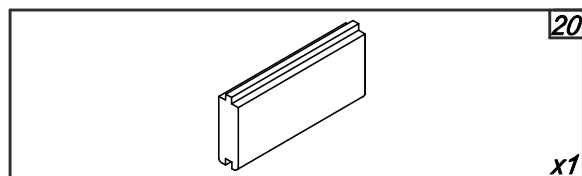
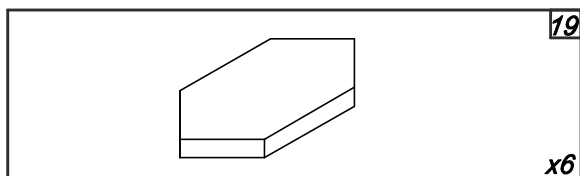
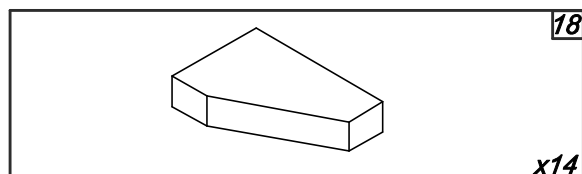
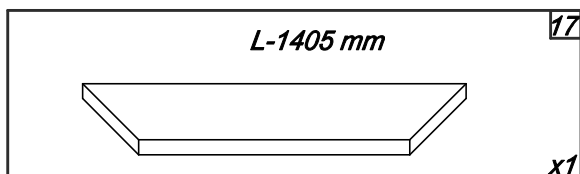
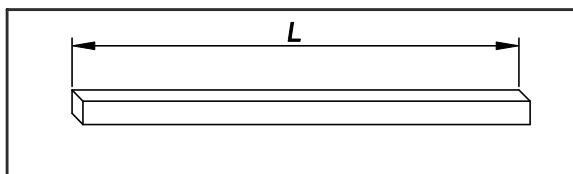

PL Okucia i osprzęt

GB Fittings and equipment

D Beschläge und Ausrüstung

FR Quincaillerie et l'équipement

IT Ferramenti e accessori

NL Bouwmaterialen



PL Sprawdź ilość.

FR Vérifiez la quantité.

GB Check quantity.

IT Controllare la quantità.

D Überprüfen Sie die Menge.

NL Controleer het aantal.

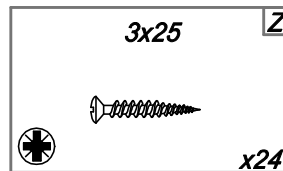
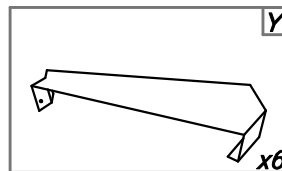
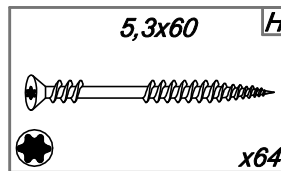
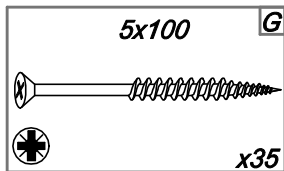
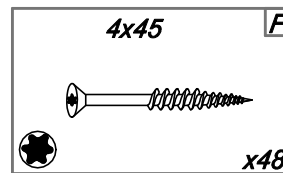
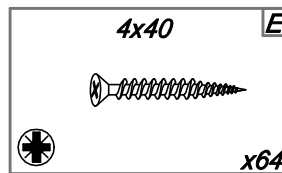
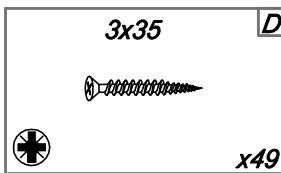
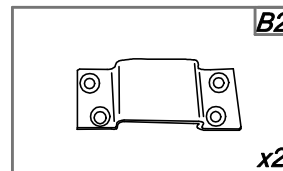
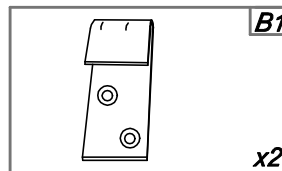

PL Narzędzia

GB Tools

D Werkzeuge

FR Les outils

IT Strumenti

NL Gereedschap

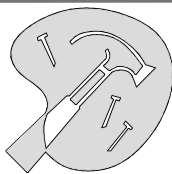

PL Przygotuj niezbędne narzędzia - niezawarte w zestawie.

FR Préparez les outils nécessaires - pas inclus.

GB Prepare essential tools- not included.

IT Preparare gli strumenti necessari - non inclusi nel set.

D Bereiten Sie notwendiges, nicht im Satz enthaltenes Werkzeug vor.

NL Benodigd gereedschap - niet inbegrepen.

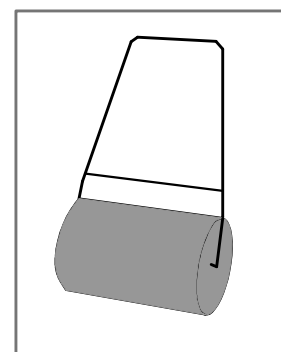
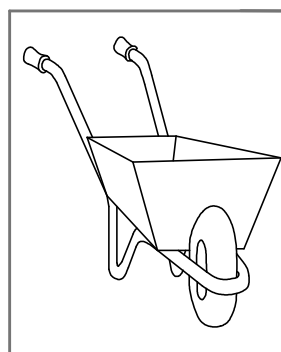
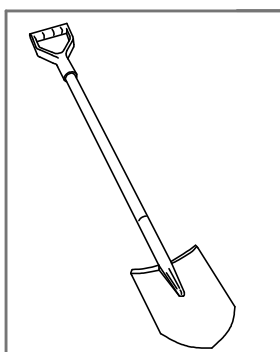
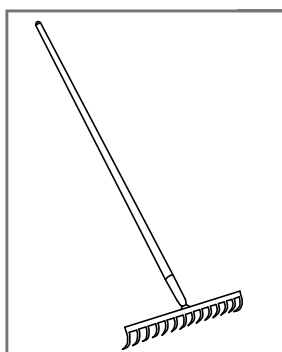
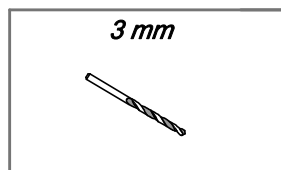
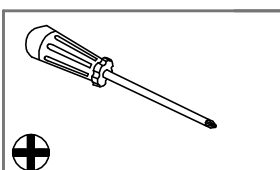
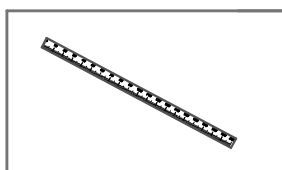
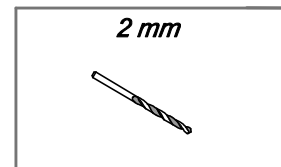
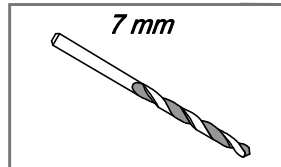
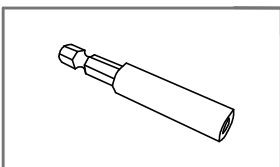
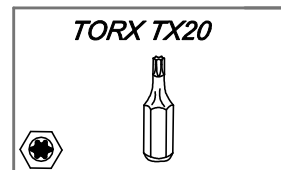
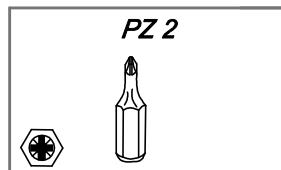
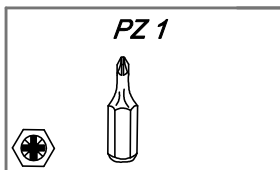
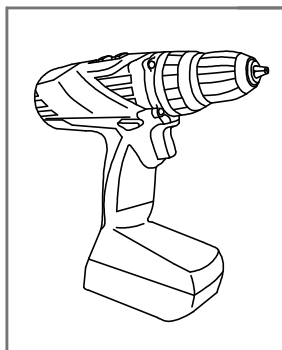
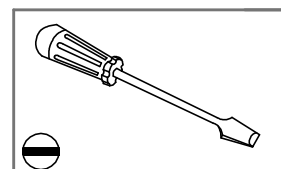
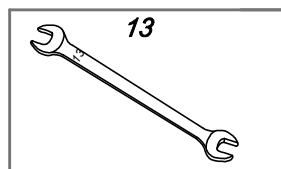
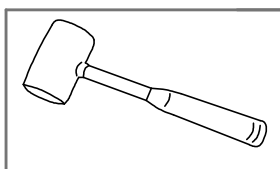
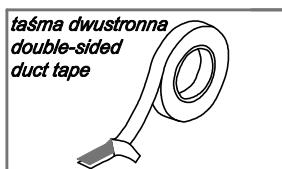
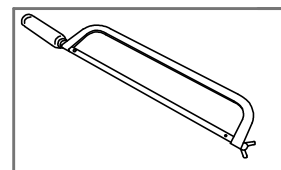
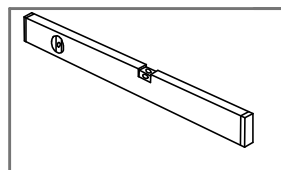
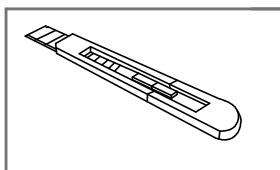
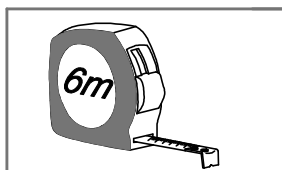
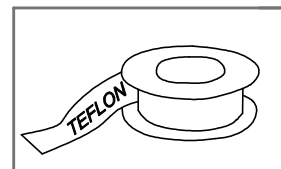
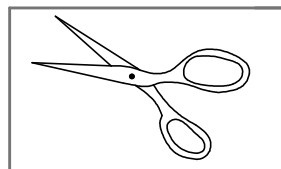
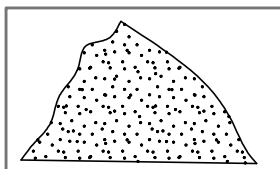
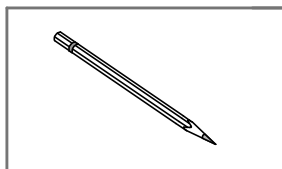

(PL) Podłoże

(GB) Ground

(D) Untergrund

(FR) Terrain

(IT) Suolo

(NL) Ondergrond



(PL) Struktura basenu wkopanego musi być zabezpieczona zgodnie z dołączoną dodatkowo dokumentacją.

(FR) Il est exigé que la structure de la piscine enterrée soit convenablement protégée selon les indices dans le document supplémentaire ci-joint.

(GB) Structure of in-ground pool must be secured in accordance with additional enclosed documentation.

(IT) È esatto che la struttura della piscina seppellita sia protetta correttamente in allegato secondo gli indizi nel documento supplementare.

(D) Die Struktur des Pools, der ausgegraben wird, muss gesichert werden, gemäß information in der Begleitdokumentation.

(NL) De constructie van het ingebouwde zwembad moet beschermd worden volgens de instructies in bijgaande documentatie.

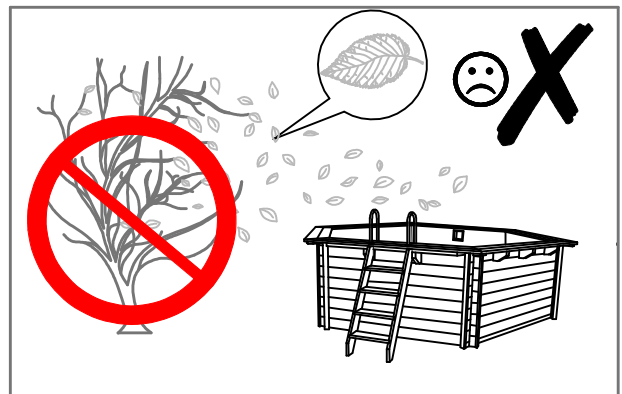
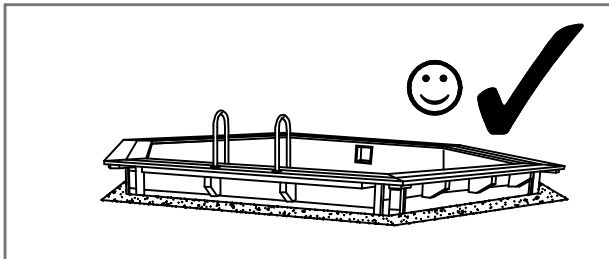
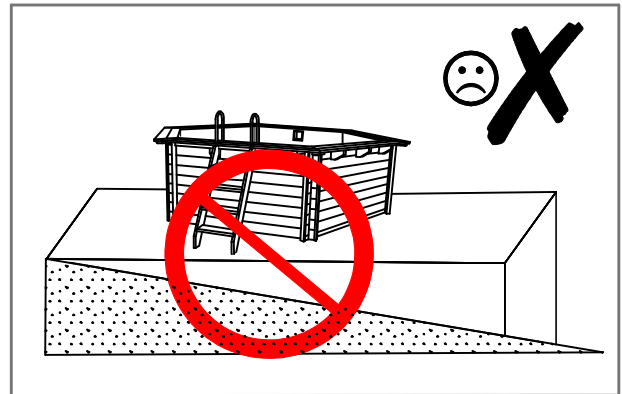
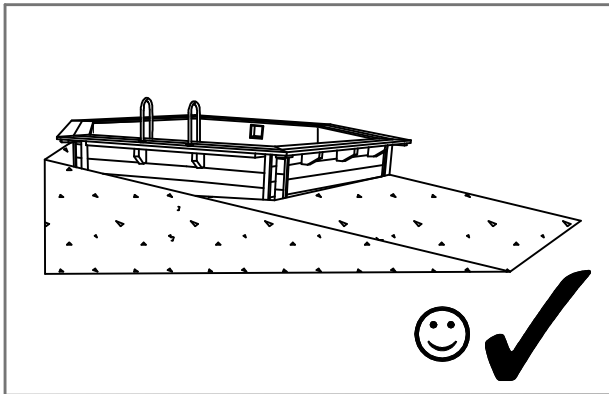
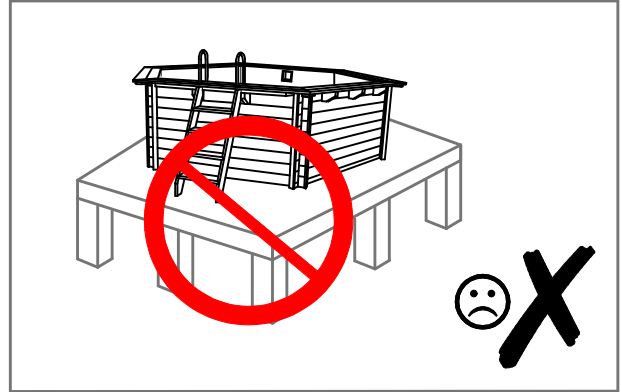
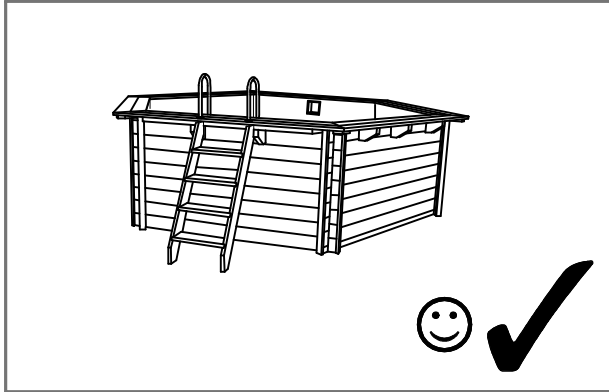

(PL) Struktura basenu w części lub w całości montowanego poniżej poziomu gruntu, musi być zabezpieczona w sposób zgodny z załączoną dodatkowo dokumentacją.

(FR) Il est exigé que la structure de la piscine enterrée ou semi-enterrée soit convenablement protégée selon les indices dans le document supplémentaire ci-joint.

(GB) Structure of partly or fully in-ground pool, must be secured in accordance with additional enclosed documentation.

(IT) È esatto che la struttura della piscina sepolta o semi-sepolta sia protetta correttamente in allegato secondo gli indizi nel documento supplementare.

(D) Die Struktur des Pools, die teilweise oder vollständig unter der Erdoberfläche montiert ist, muss gemäß der beiliegenden Dokumentation gesichert werden.

(NL) De constructie van het half- of volledig ingebouwde zwembad moet beschermd worden volgens de instructies in bijgaande documentatie.

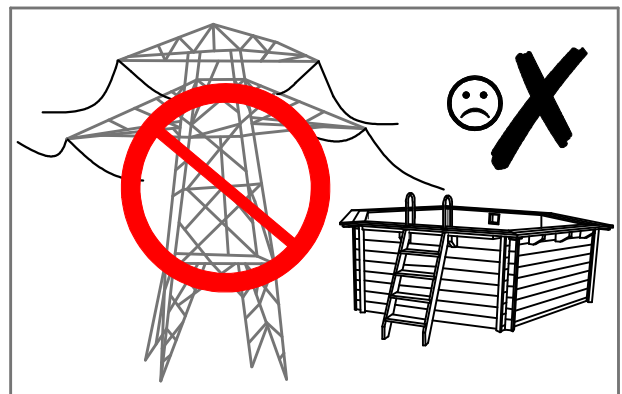

(PL) Podłoże

(GB) Ground

(DE) Untergrund

(FR) Terrain

(IT) Suolo

(NL) Ondergrond



- (PL)** Wymagane zabezpieczenie struktury przy montażu basenu poniżej poziomu gruntu.
(FR) La protection de la structure dans le cas de la piscine totalement ou partiellement enterrée.
(GB) Wooden structure protection required in case of in-ground installation.
(IT) La protezione della struttura nel caso della piscina totalmente o parzialmente sepolta.
(DE) Erforderliches Schutz für Struktur eines Holzpool, wenn es unter der Boden montieren.
(NL) Bescherming van de houten constructie is absoluut noodzakelijk bij ingebouwde zwembaden.

- 1** FUNDAMENT BASENU / DALLE BETON / FOUNDATION / LASTRA CEMENTO / DAS FUNDAMENT / FUNDERING
- 2** RURA DRENARSKA / TUYAU DE DRAINAGE / DRAINAGE PIPE / TUBO DI DRENAGGIO / DIE DRAINAGEROH / AFVOERPIJP
- 3** PEÇHERZYKOWA FOLIA FUNDAMENTOWA / PROTECTION DE SOUBASSEMENT / FOINDATION BUBBLE WRAP / FONDALINE / DAS FUNDAMENT NOPPENFOLIE / BOUWFOLIE
- 4** ŻWIR / GRAVIER / GRAVEL / GHIAIA / DER KIES / GRAVEL
- 5** GEOWŁÓKNINA OGRODOWA / GEOTEXTILE / GEOTEXTILE / GEOTESSILI / GARTEN GEOTEXTILE / GEOTEXTEL
- 6** GRUNT / TERRAIN / GROUND / TERRENO / DER BODEN / BODEM

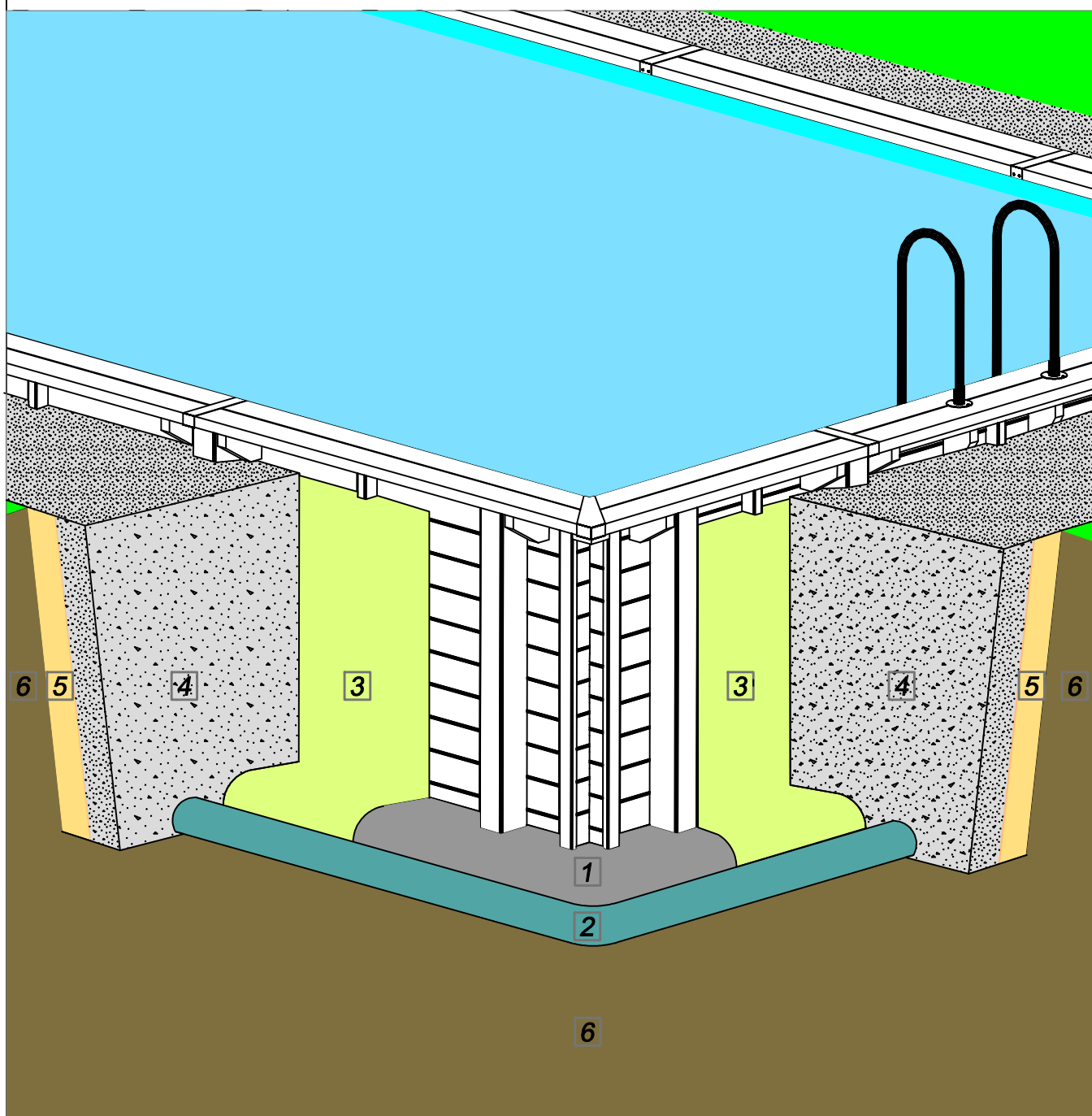

PL Podłoże

GB Ground

D Untergrund

FR Terrain

IT Suolo

NL Ondergrond



PL Ułóż pierwszą warstwę w celu wyznaczenia terenu pod basen.

FR Posez la première couche afin de marquer le terrain sous la piscine.

GB Lay first layer to determine the surface for the pool.

IT Posare il primo strato al fine di determinare il terreno per la piscina.

D Legen Sie die erste Schicht zur Bestimmung des für Swimmingpool vorgesehenen Geländes auf.

NL Monteer de eerste laag balken om te bepalen waar het zwembad komt.

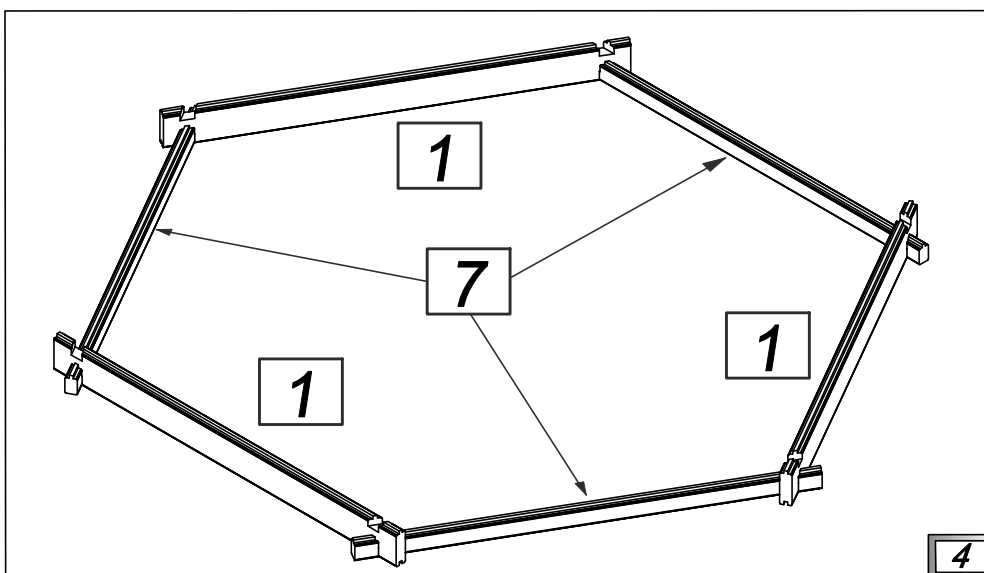
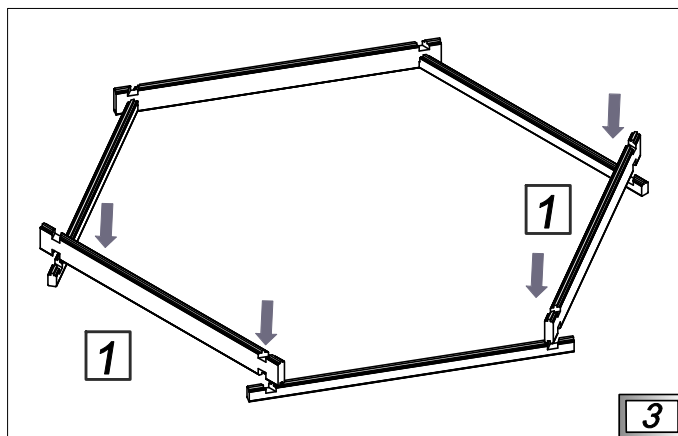
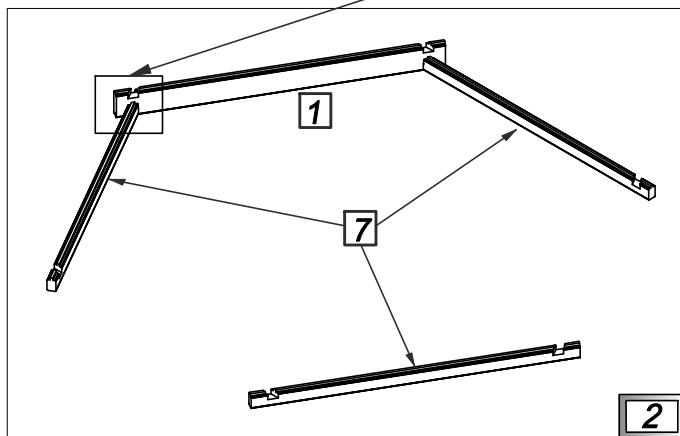
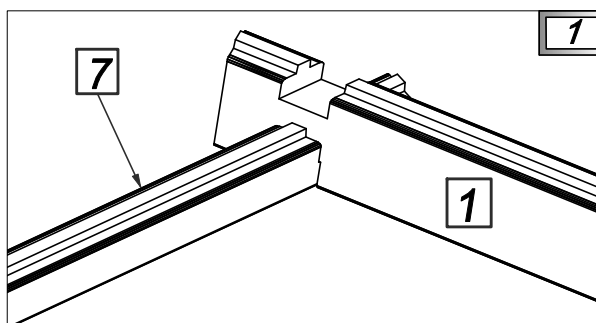
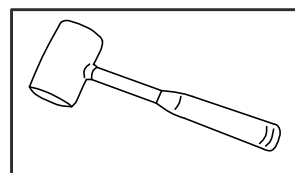
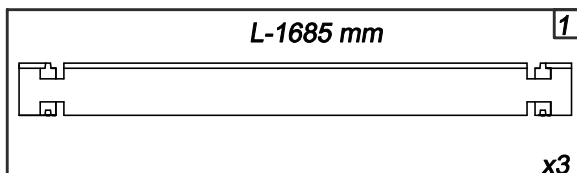
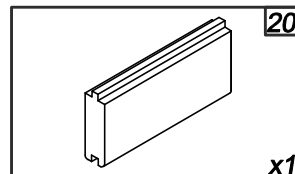
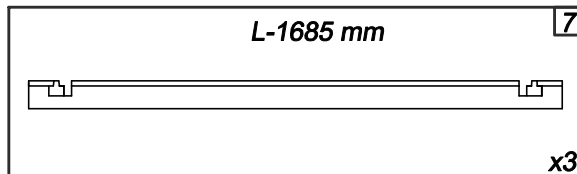
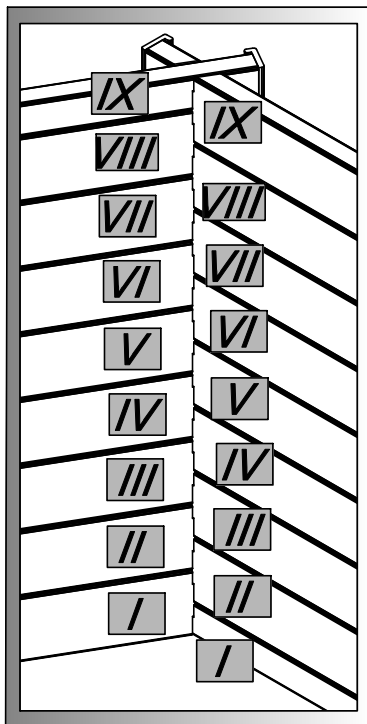

PL Podłoże

GB Ground

D Untergrund

FR Terrain

IT Suolo

NL Ondergrond

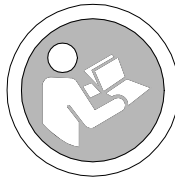

PL Wyznacz teren po czym rozmontuj strukturę. Usuń trawę, korzenie, kamienie.

FR Marquez le terrain et ensuite déplacez les éléments bois. Nettoyez bien le terrain en enlevant les herbes, les racines et les cailloux.

GB Mark the surface, then demount a structure. Remove grass, roots, rocks.

IT Determinare il terreno e poi smontare la struttura. Togliere erba, radici, pietre.

D Stecken Sie das Gelände auf und bauen Sie die Struktur aus. Entfernen Sie Gras, Wurzel, Steine.

NL Markeer de oppervlakte haal de eerst laag weg. Verwijder gras, wortels, stenen.

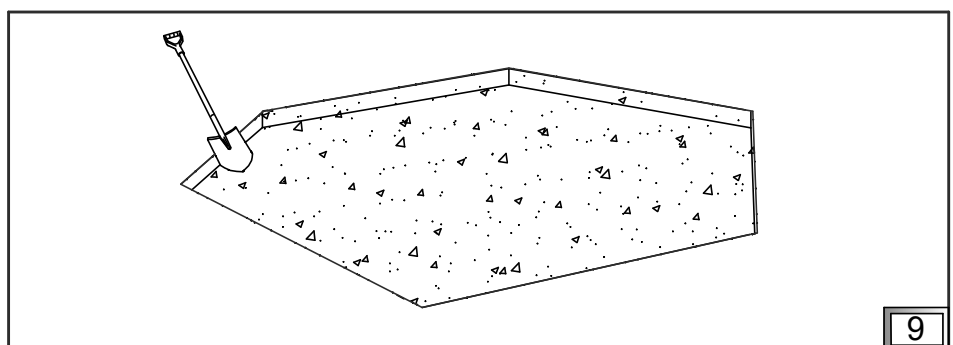
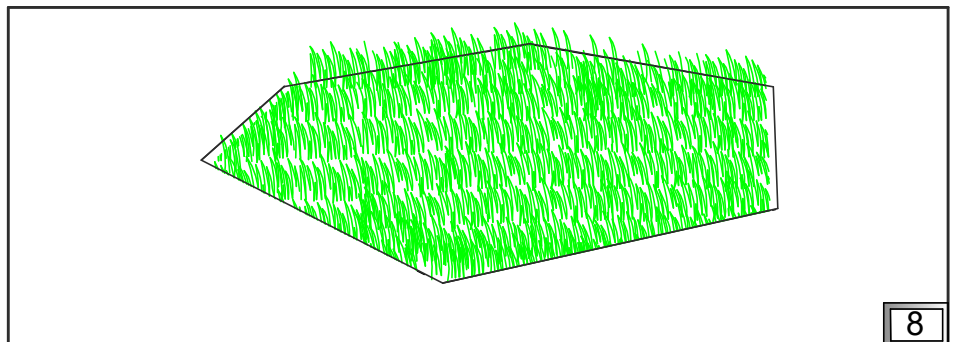
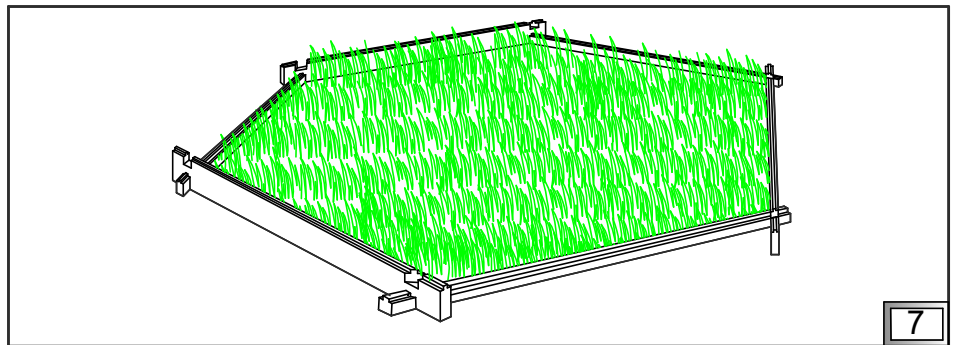
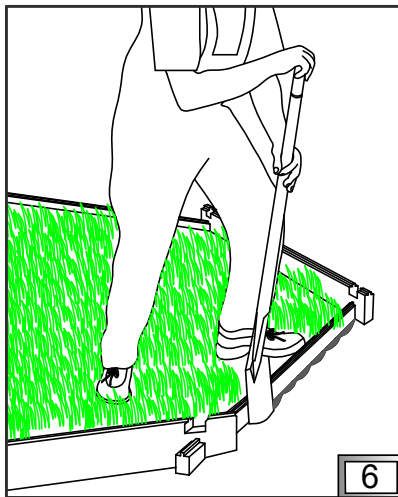
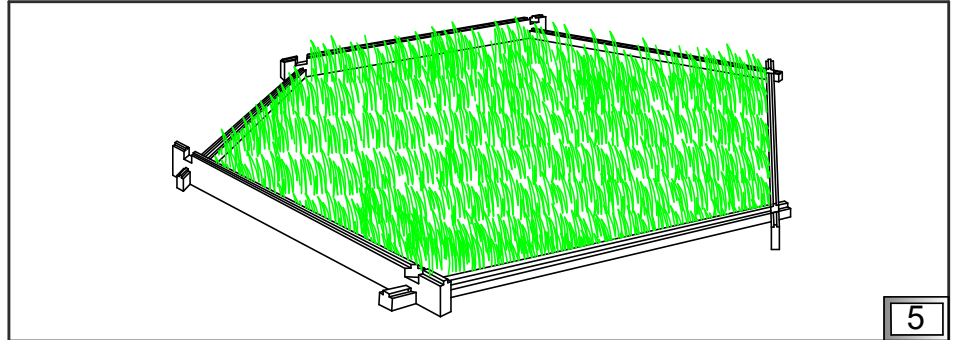
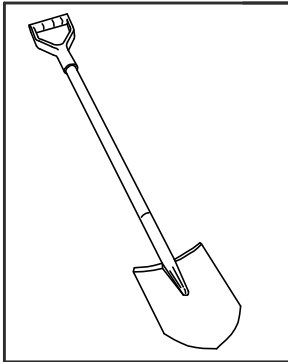

PL Podłoże

GB Ground

D Untergrund

FR Terrain

IT Suolo

NL Ondergrond



PL Wysyp piasek. Powierzchnia musi być twarda, płaska i wypoziomowana. Ułóż ponownie warstwę I.

FR Etalez du sable et refaites la couche I. Le terrain doit être rigoureusement plat, dur et de niveau.

GB Pour the sand. The surface must be firm, flat and leveled. Mount layer I again.

IT Versare sabbia. La superficie deve essere solida, piana e livellata. Posizionare di nuovo lo strato I.

D Schütten Sie Sand aus. Der Untergrund muss fest, flach und eben sein. Legen Sie die I-Schicht erneut auf.

NL Vul de ondergrond met schoon zand, de ondergrond moet stevig, vlak en waterpas zijn, monteer de eerste laag weer.

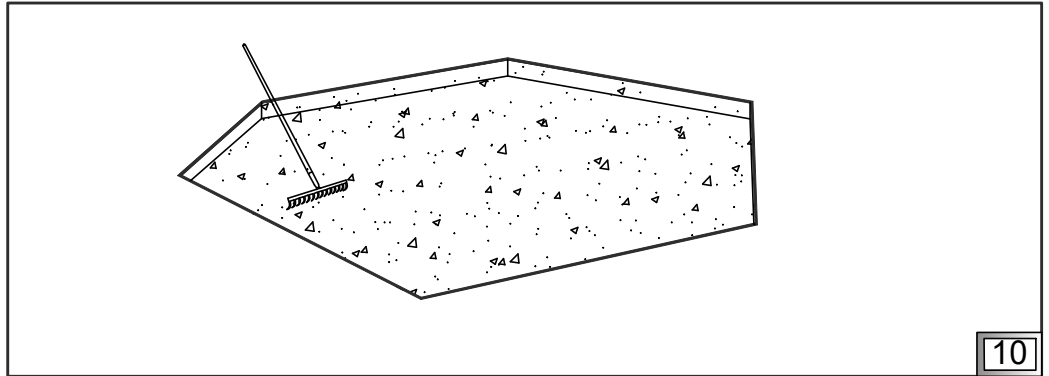
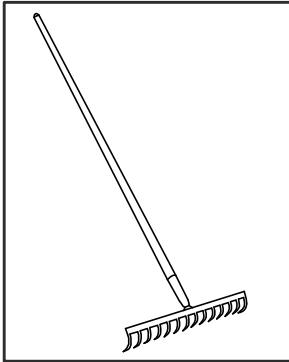

10

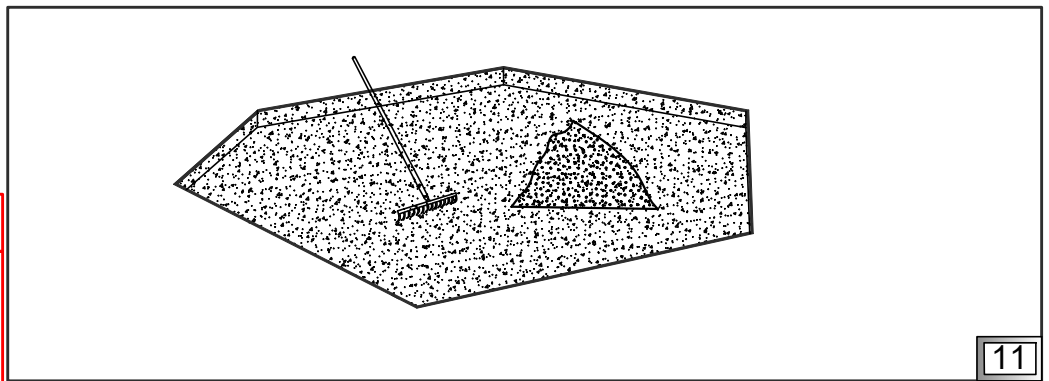
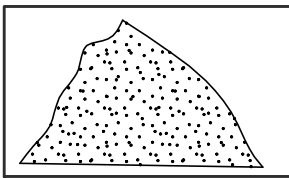

11

PL Piasek - warstwa 2 cm.
FR Le sable - une couche de 2 cm.
GB Sand - layer 2 cm.
IT Sabbia - uno strato di 2 cm.
D Sand - Schicht 2 cm.
NL Zandlaag 2cm

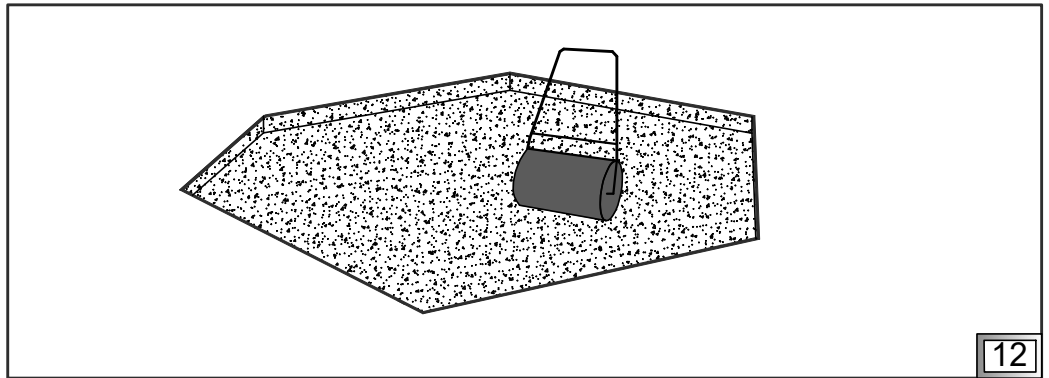
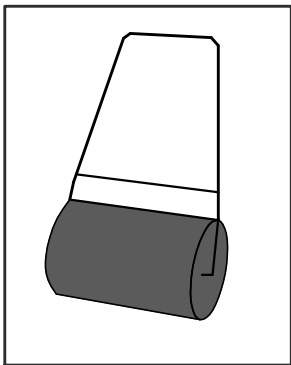

12

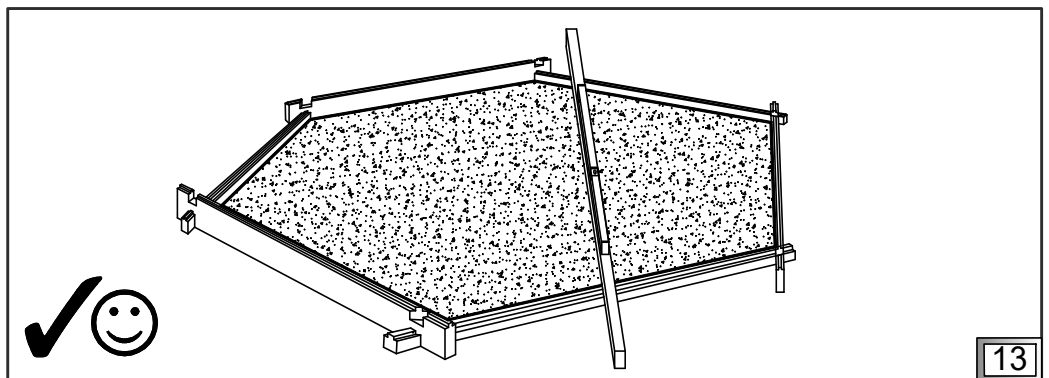
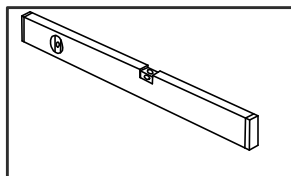

13

(PL) Struktura drewniana

(GB) Wooden structure

(D) Holzstruktur

(FR) La structure bois

(IT) Struttura in legno

(NL) Houten structuur



(PL) Po ułożeniu każdej z warstw sprawdź przekątne D według rysunku.

(FR) Vérifiez les diagonales "D" après la pose de chaque tour .

(GB) After putting each layer check D diagonals according to the drawing.

(IT) Dopo la posa di ogni strato bisogna controllare diagonali D, secondo il disegno.

(D) Nach Verlegen von jeder Schicht kontrollieren Sie D-Diagonale nach Schema.

(NL) Na het bouwen van de eerste laag controleer D diagonalen volgens de tekening.

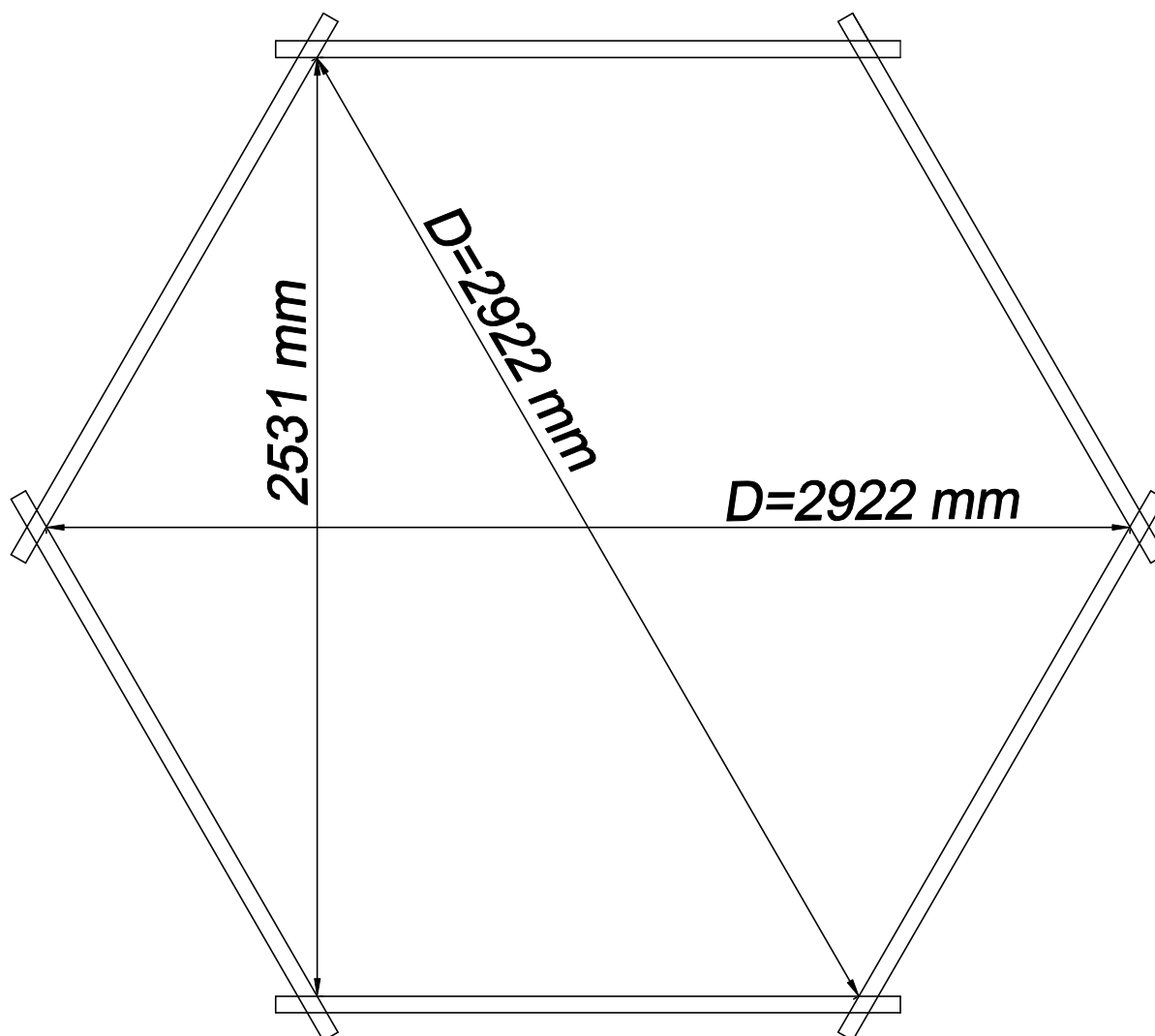
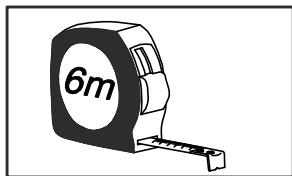

PL Struktura drewniana

GB Wooden structure

D Holzstruktur

FR La structure bois

IT Struttura in legno

NL Houten structuur



PL Ułożenie kolejnych warstw. Sprawdzaj przekątną D po każdej ułożonej warstwie.

FR L'assemblage des couches suivantes. Vérifiez les diagonales "D" après la pose de chaque tour.

GB Putting next layers. Check D diagonals every layer.

IT La messa degli strati successivi. Trova la diagonale D dopo ogni strato.

D Verlegen der nachfolgenden Schichten. Nach Verlegen von jeder Schicht kontrollieren Sie die D-Diagonale.

NL Installeer de volgende lagen en controleer diagonaal D.

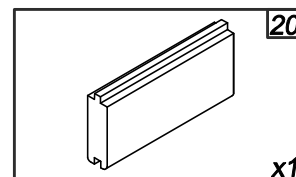
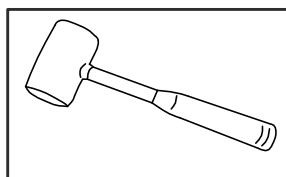
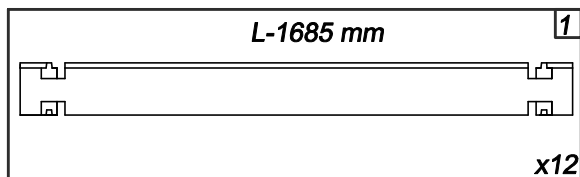

II-III

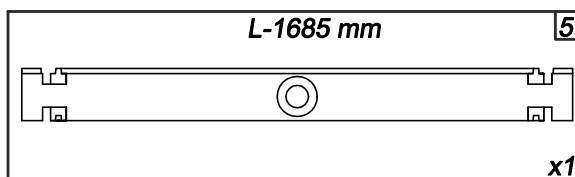
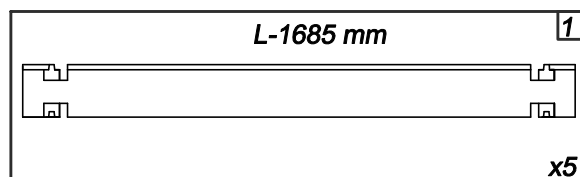
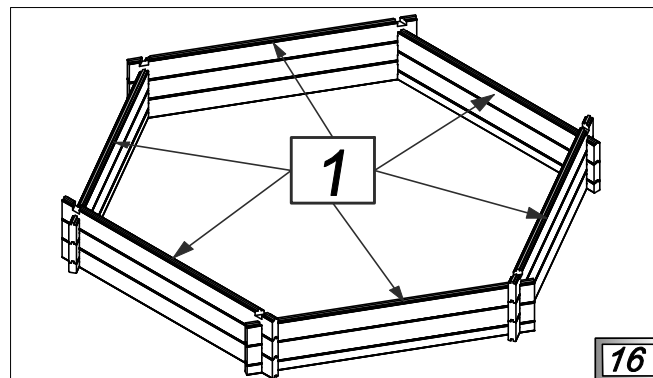
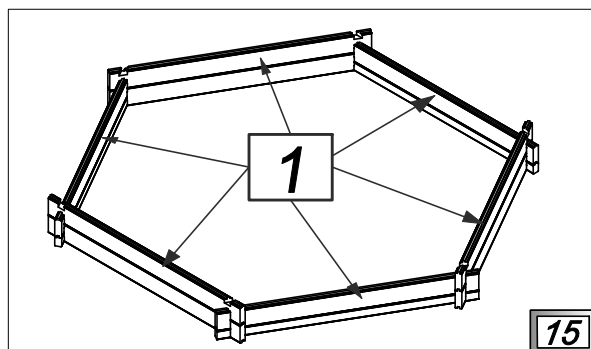
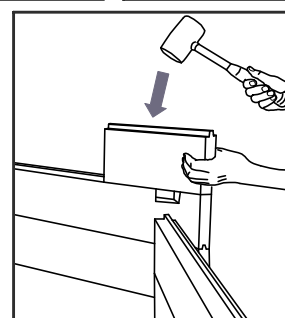
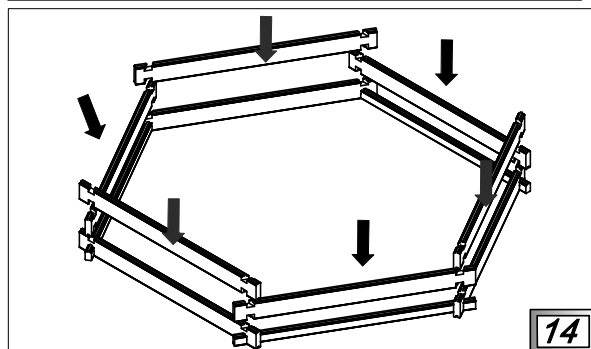

IV

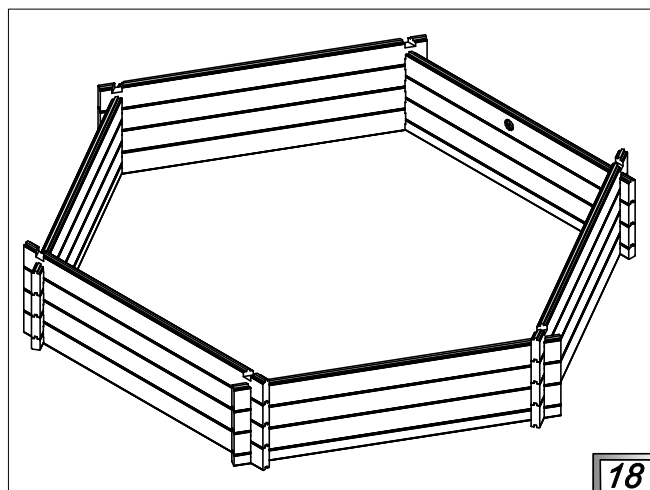
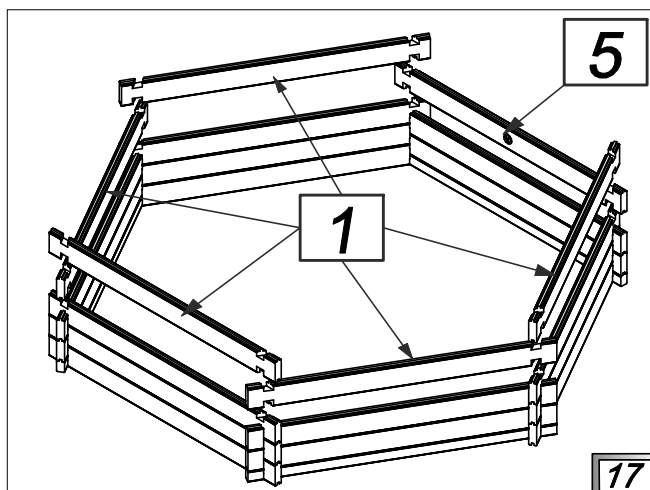

PL Struktura drewniana

GB Wooden structure

D Holzstruktur

FR La structure bois

IT Struttura in legno

NL Houten structuur



PL Ułożenie kolejnych warstw. Sprawdzaj przekątną D po każdej ułożonej warstwie.

FR L'assemblage des couches suivantes. Vérifiez les diagonales "D" après la pose de chaque tour.

GB Putting next layers. Check D diagonals every layer.

IT La messa degli strati successivi. Trova la diagonale D dopo ogni strato.

D Verlegen der nachfolgenden Schichten. Nach Verlegen von jeder Schicht kontrollieren Sie die D-Diagonale.

NL Installeer de volgende lagen en controleer diagonaal D.

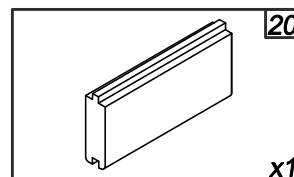
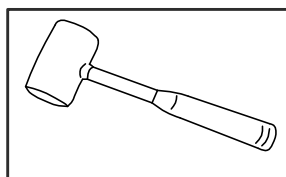
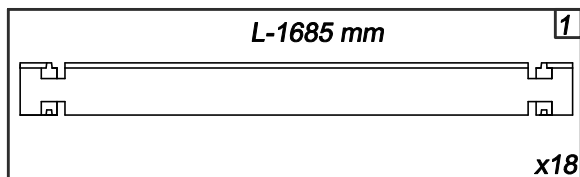

V-VII

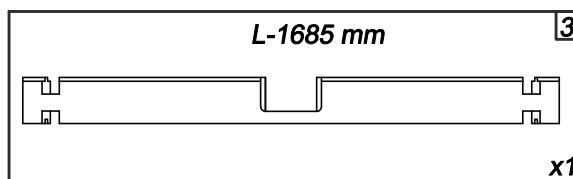
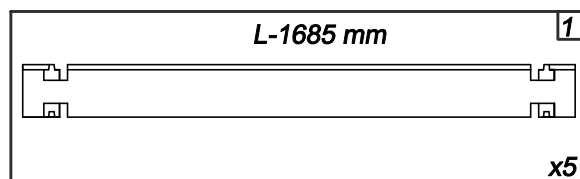
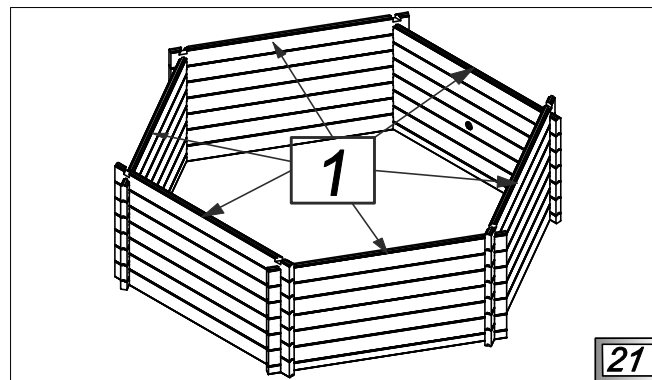
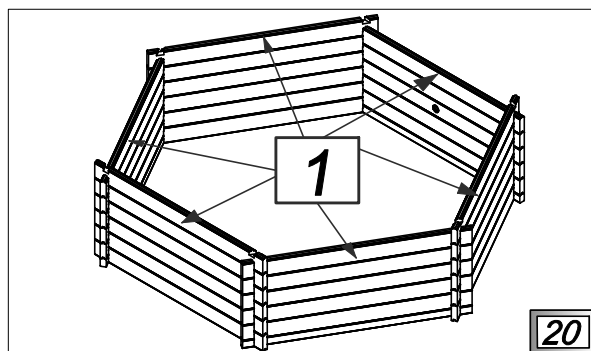
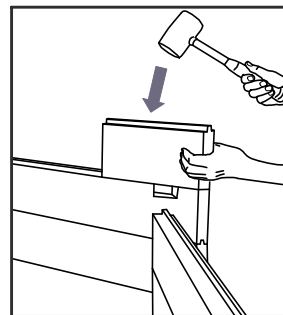
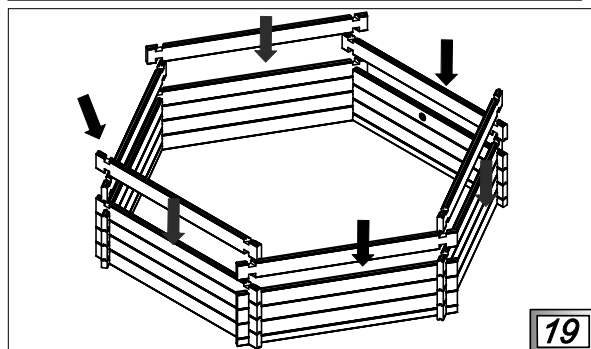

VIII

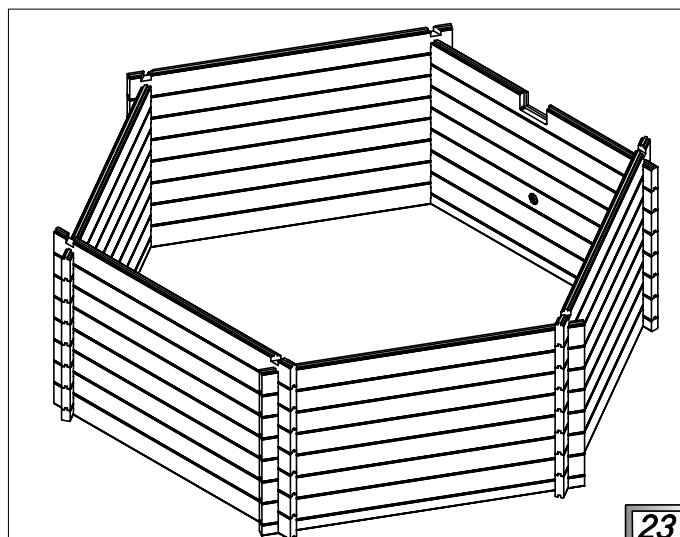
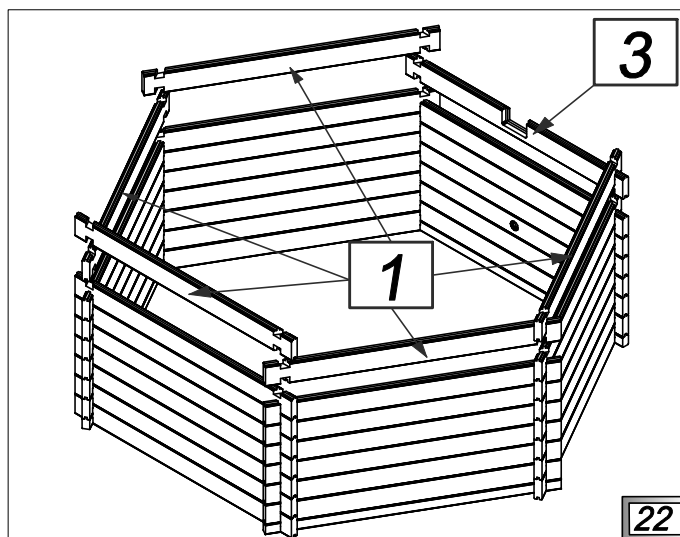

(PL) Struktura drewniana

(GB) Wooden structure

(D) Holzstruktur

(FR) La structure bois

(IT) Struttura in legno

(NL) Houten structuur



(PL) Ułożenie kolejnych warstw. Sprawdzaj przekątną D po każdej ułożonej warstwie.

(FR) L'assemblage des couches suivantes. Vérifiez les diagonales "D" après la pose de chaque tour.

(GB) Putting next layers. Check D diagonals every layer.

(IT) La messa degli strati successivi. Trova la diagonale D dopo ogni strato.

(D) Verlegen der nachfolgenden Schichten. Nach Verlegen von jeder Schicht kontrollieren Sie die D-Diagonale.

(NL) Installeer de volgende lagen en controleer diagonaal D.

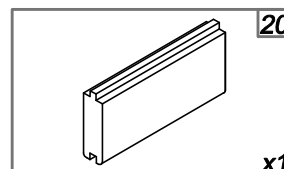
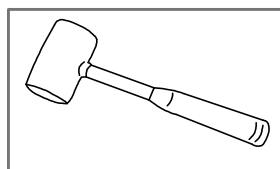
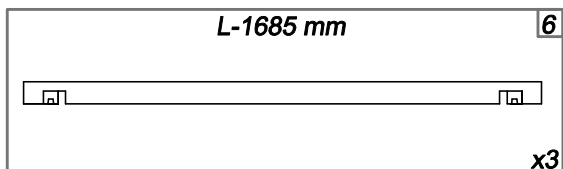
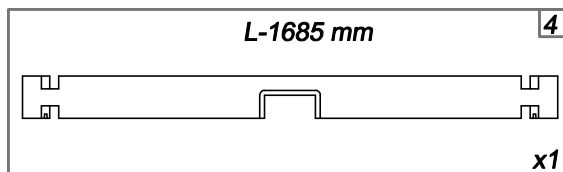
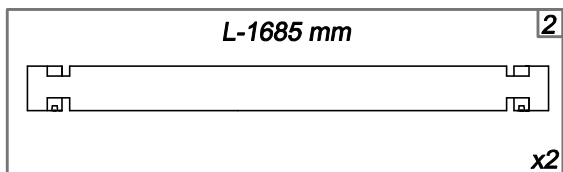

IX

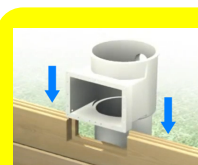
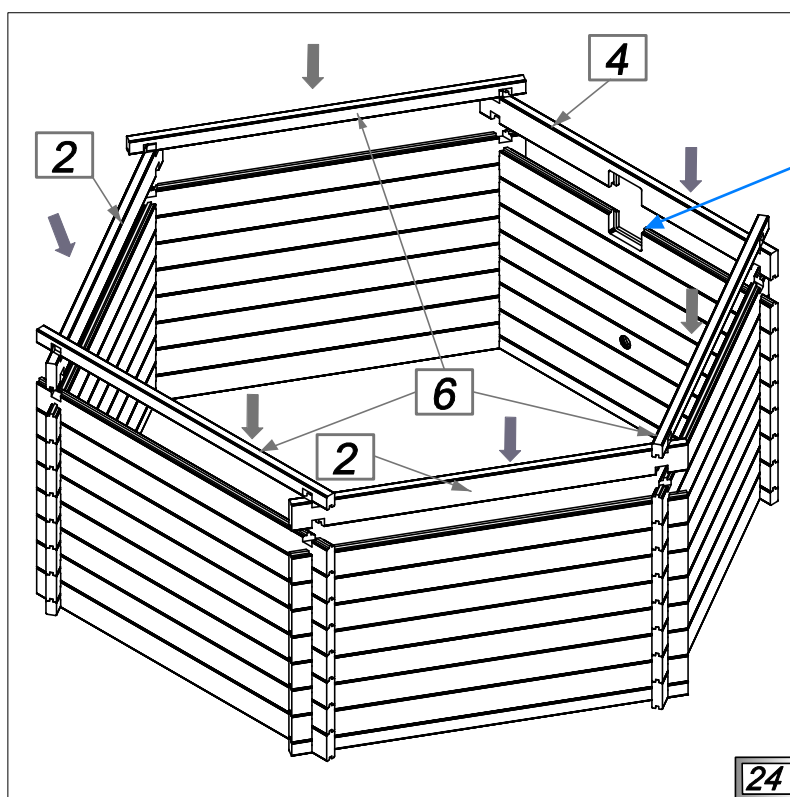

ATTENZIONE!
Posizionare lo SKIMMER prima di inserire la semitavola superiore. Vedi le istruzioni di montaggio degli accessori per tutti i dettagli.

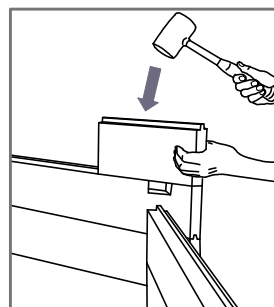
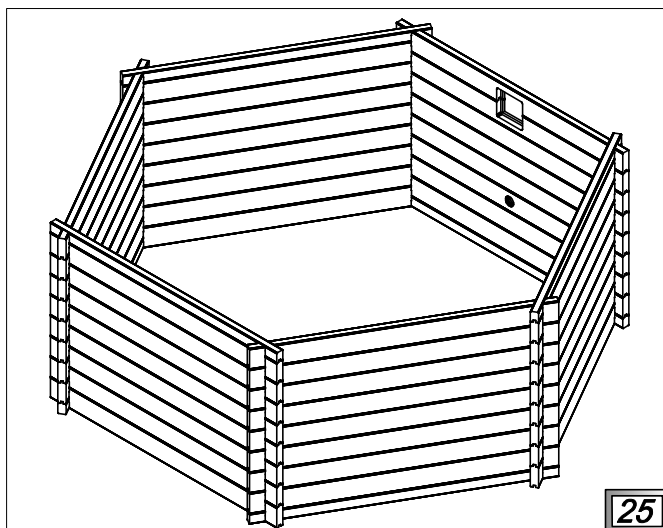

(PL) Struktura drewniana

(GB) Wooden structure

(D) Holzstruktur

(FR) La structure bois

(IT) Struttura in legno

(NL) Houten structuur



- (PL)** Montaż wspornika schodów (17).
- (FR)** Le montage du renfort d'escalier (17).
- (GB)** Installation of stairs support (17).
- (IT)** Montaggio delle scale a sbalzo (17).
- (D)** Montage von Treppenstützen(17).
- (NL)** Installatie van de steun voor de trap (17).

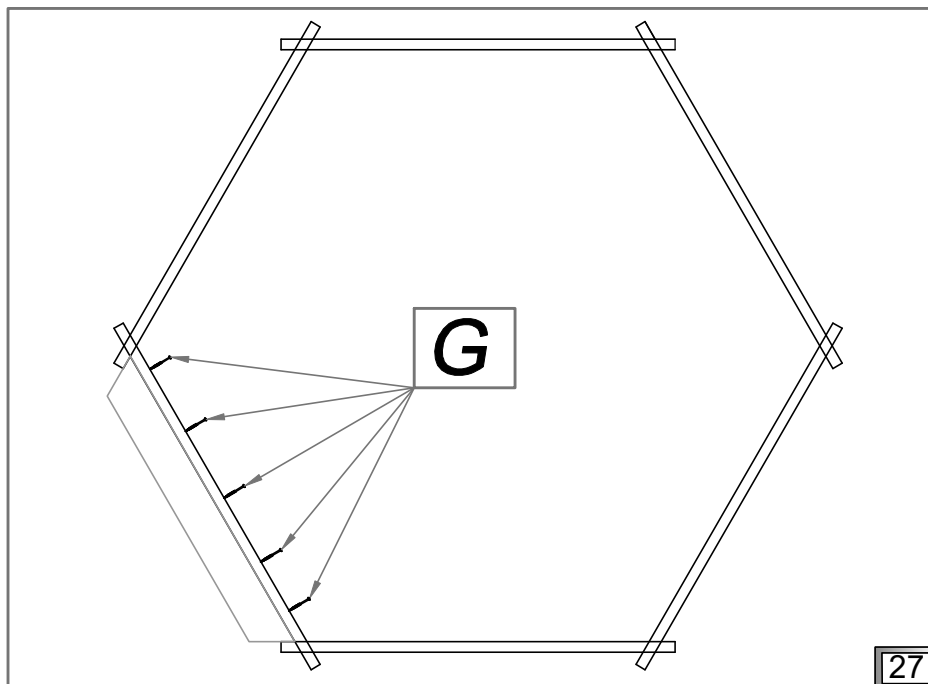
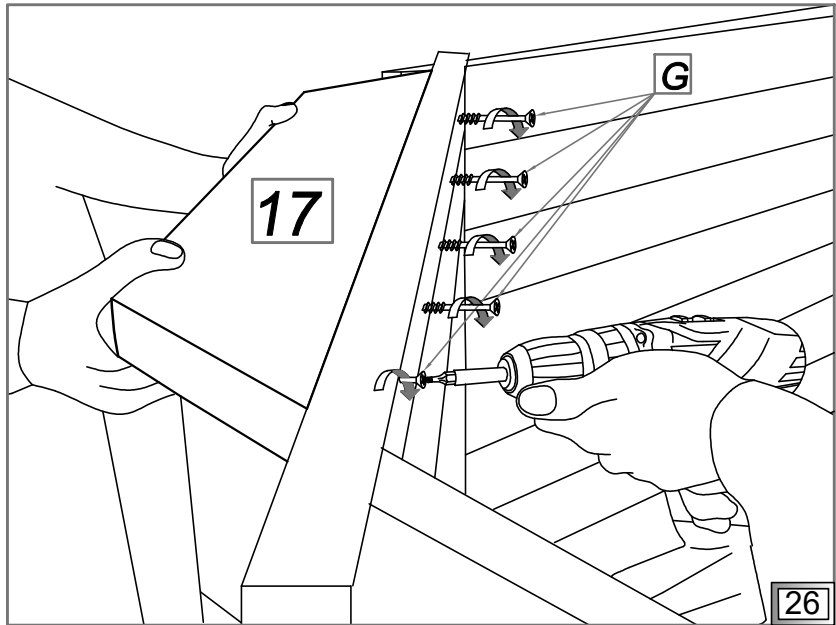
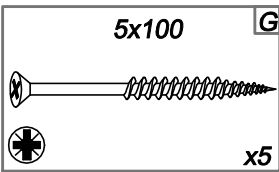
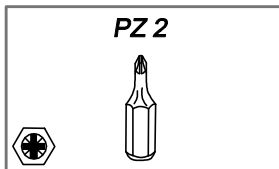
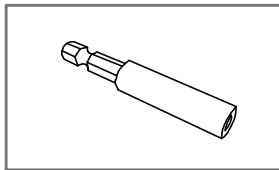
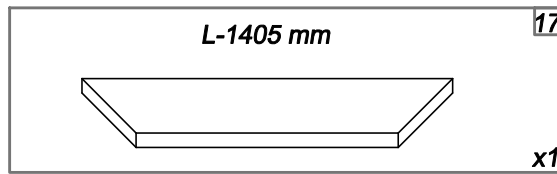
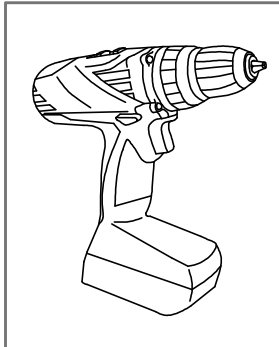

PL Struktura drewniana

GB Wooden structure

D Holzstruktur

FR La structure bois

IT Struttura in legno

NL Houten structuur



PL Rozłożenie konsol (18) według schematu.

FR La disposition des supports des margelles (18) d'après le schéma.

GB Arrangement of consoles (18) according to the drawing.

IT La distribuzione degli delle console (18) secondo lo schema.

D Verteilung der Konsolen (18) nach Schema.

NL Montage van de consoles (18) volgens tekening.

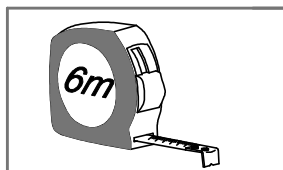

[mm]

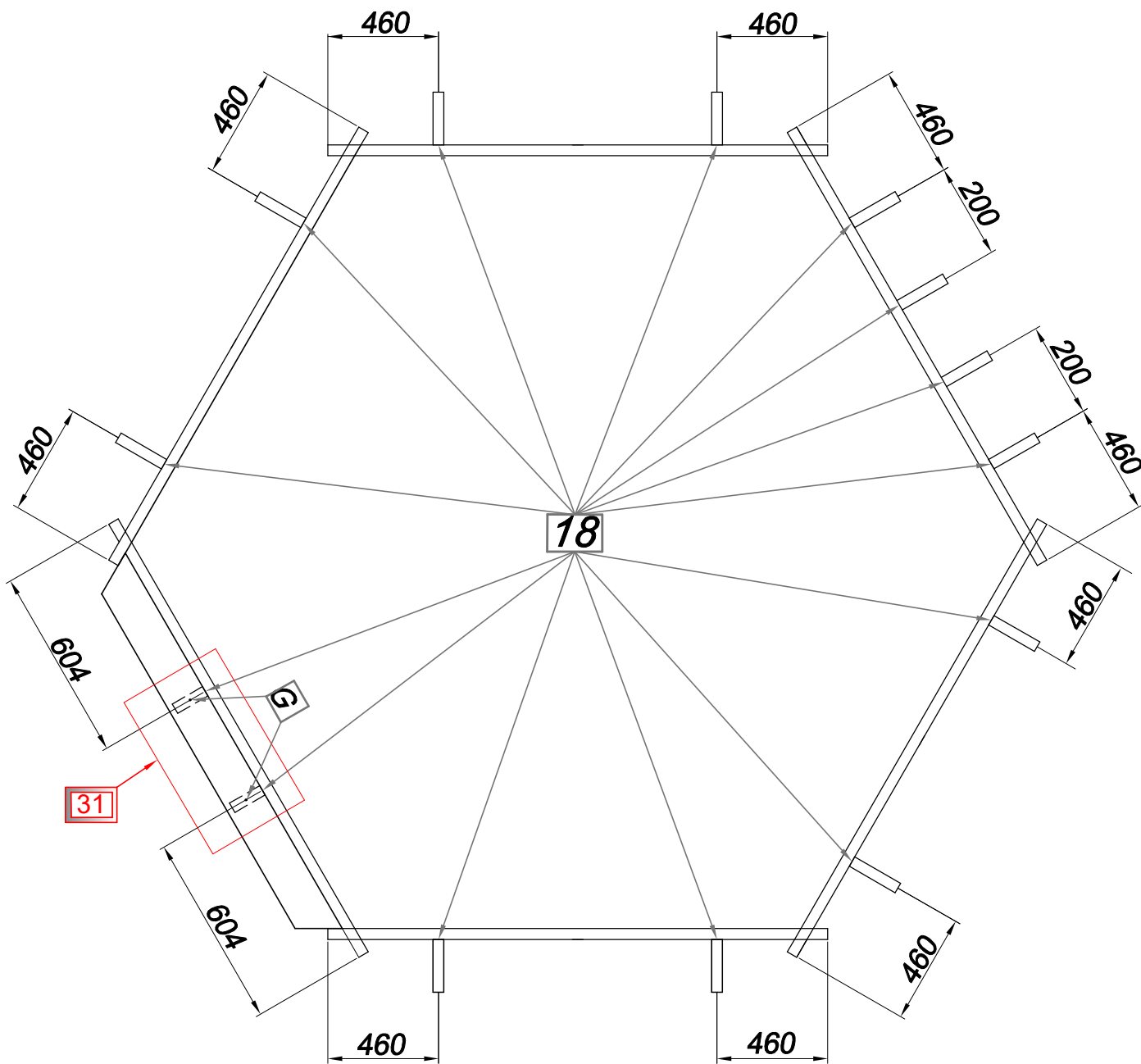

PL Struktura drewniana

GB Wooden structure

D Holzstruktur

FR La structure bois

IT Struttura in legno

NL Houten structuur



PL Montaż konsol (18). Konsole montowane pod wspornikiem schodów (17) według rysunku 31.

FR Le montage des supports des margelles (18). Montez les supports des margelles sous un renfort d'escalier (17) d'après le dessin 31.

GB Installation of consoles (18). Consoles under ladder support (17) installed according to the drawing 31.

IT Il montaggio di console (18). Console sono montate sotto lo sbalzo della scala (17), come mostrato sul disegno 31.

D Konsolenmontage (18). Die Konsolen werden unter den Treppenstützen (17) nach Abb 31 montiert.

NL Installatie van de consoles (18). Consoles onder de ladder steun (17) volgens tekening 31.

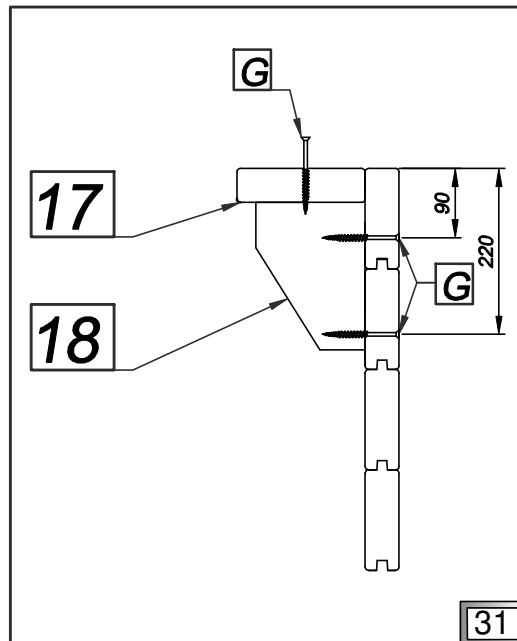
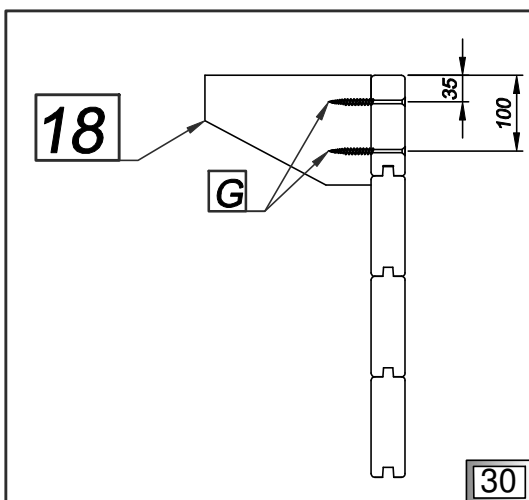
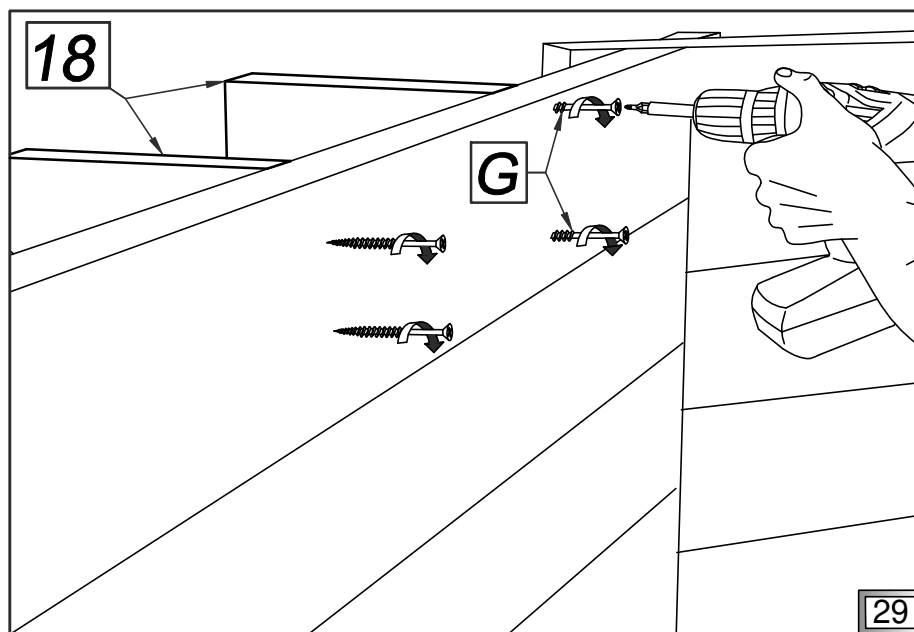
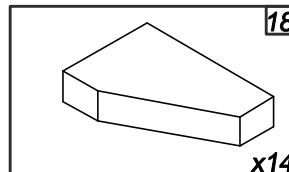
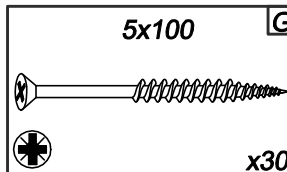
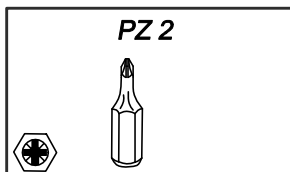
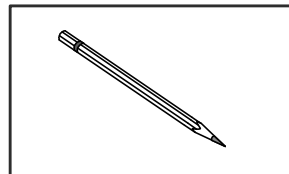
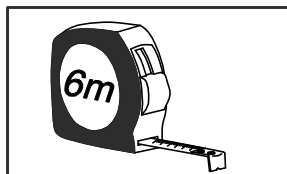
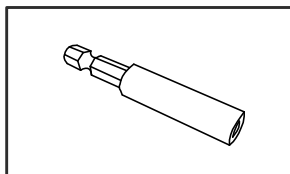
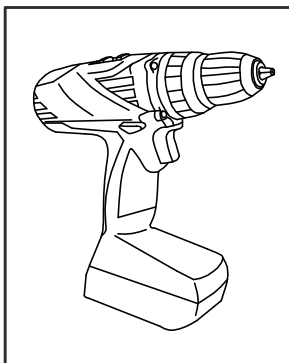

(PL) Struktura drewniana

(GB) Wooden structure

(D) Holzstruktur

(FR) La structure bois

(IT) Struttura in legno

(NL) Houten structuur



(PL) Montaż maskownicy 57 mm (14).

(FR) Le montage des caches 57 mm (14).

(GB) Installation of the masking element 57 mm (14).

(IT) Montaggio del mascherino 57 mm (14).

(D) Montage der Abdeckung 57 mm (14).

(NL) Installatie van de afwerklát 57mm (14) voor de kopse kanten van de wanddelen.

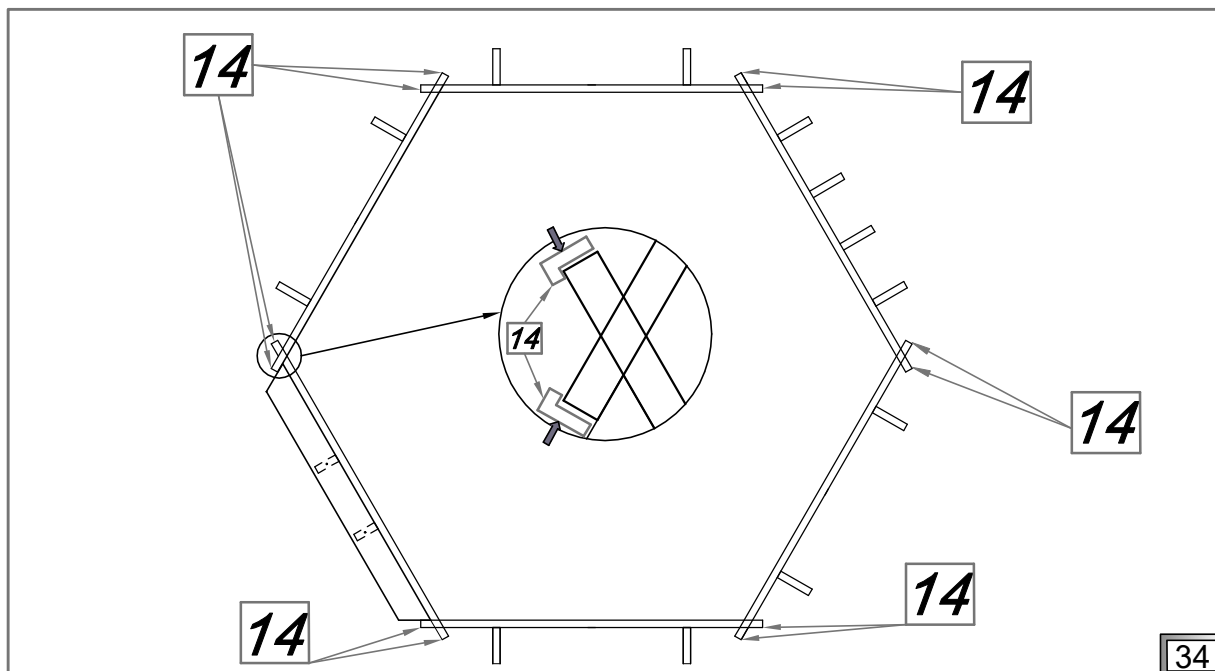
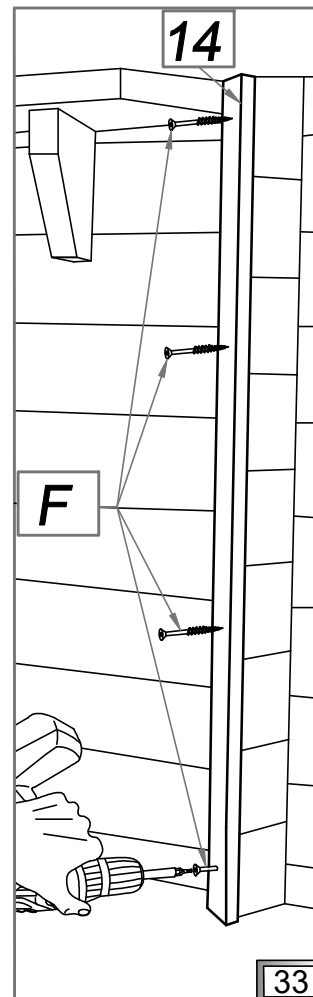
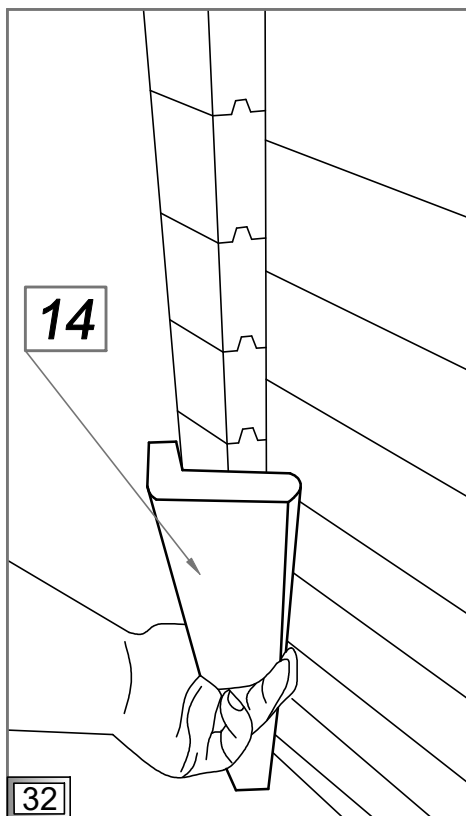
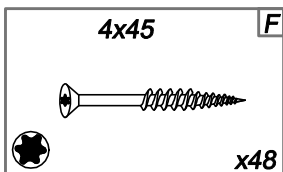
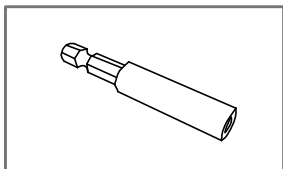
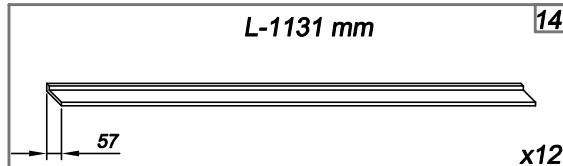
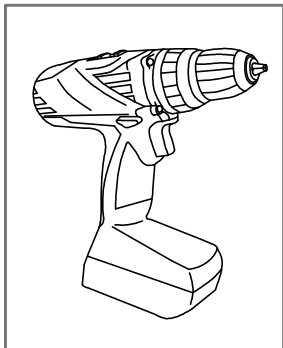

PL Taras

GB Terrace

D Terrasse

FR Les margelles

IT Terrazza

NL Bovenrand



- PL** Montaż desek tarasowych.
- FR** Le montage des margelles.
- GB** Installation of terrace boards.
- IT** Installazione delle tavole da terrazza.
- D** Montage vom Terrassenholz.
- NL** Installatie van de bovenrand.

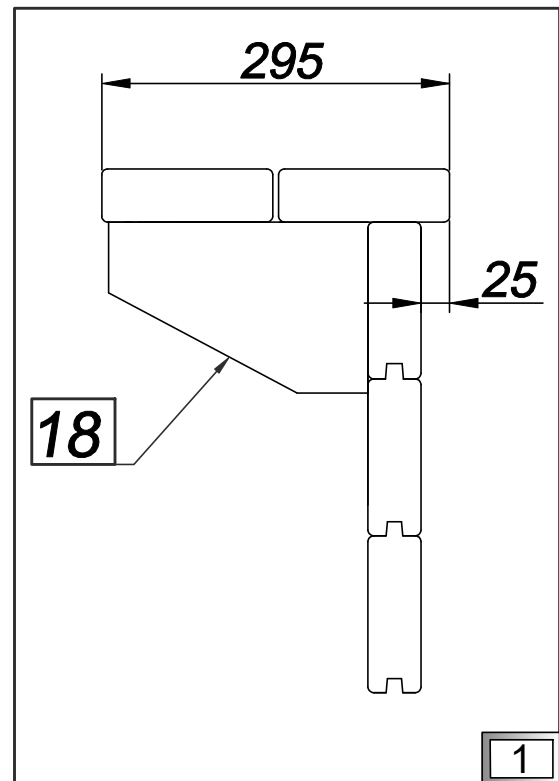
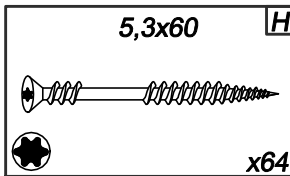
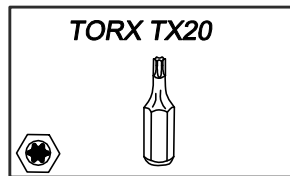
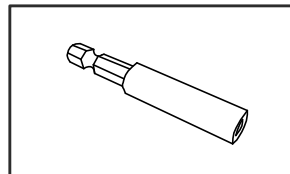
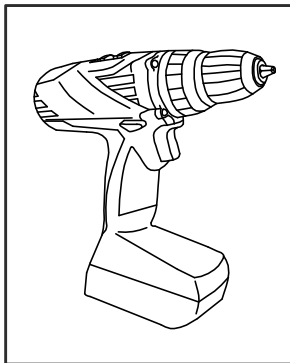
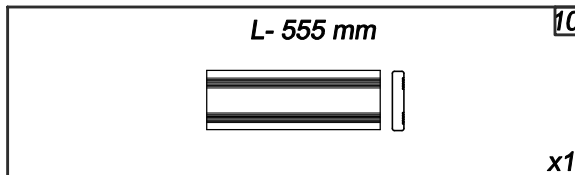
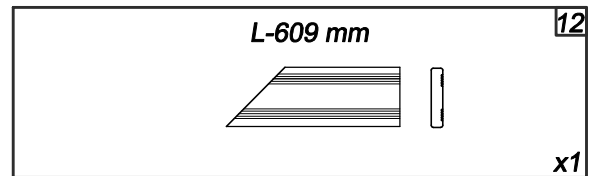
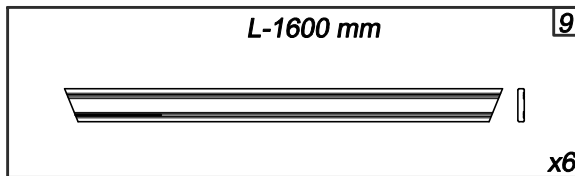
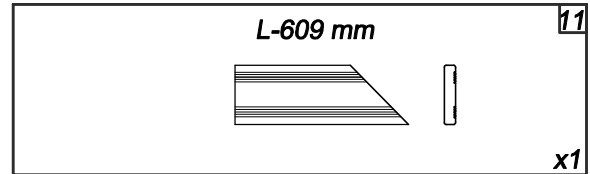
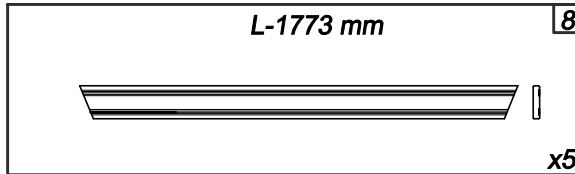

PL Taras

GB Terrace

D Terrasse

FR Les margelles

IT Terrazza

NL Bovenrand



- PL** Zamocuj deski tarsowe wedlug rysunku.
- FR** Faites monter les margelles suivant le dessin.
- GB** Mount terrace boards according to the drawing.
- IT** Montare le tavole da terrazza secondo il disegno.
- D** Befestigen Sie das Terrassenholz nach der Abbildung.
- NL** Monteer de bovenrand volgens tekening.

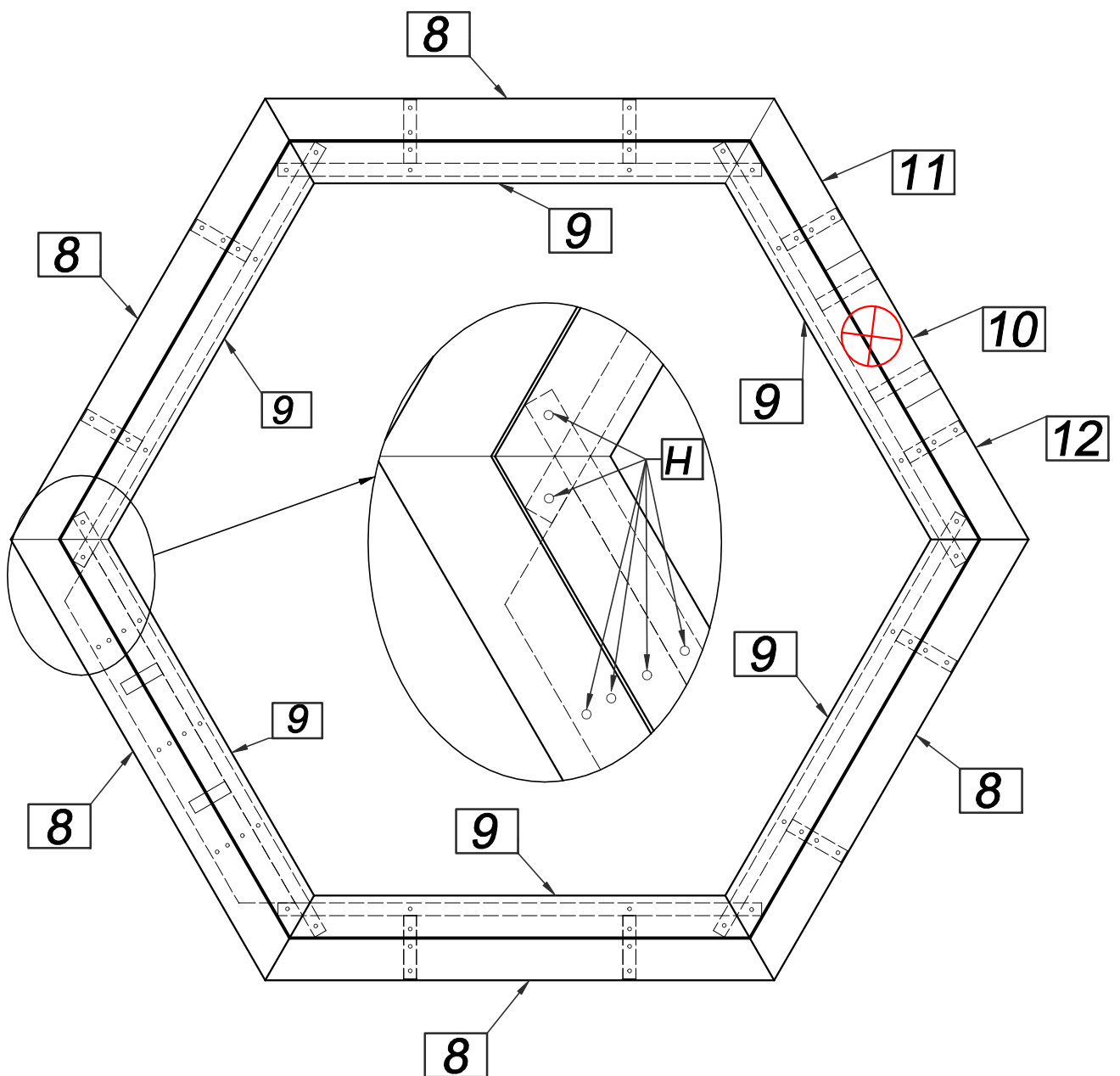
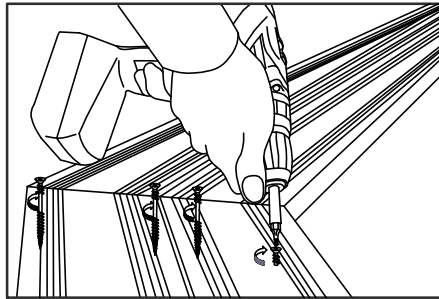

(PL) Zawiasa tarasu skimmera **(GB)** Skimmer terrace hinge **(DE)** Skimmer Terrassenscharnier
(FR) Charnière de terrasse skimmer **(NL)** Skimmer terrasscharnier

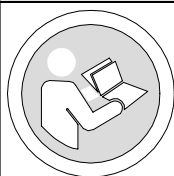

(PL) Montaż zawiasy tarasu skimmera - przykładowy sposób montażu.
(FR) Montez la charnière de terrasse du skimmer.
(GB) Mount the skimmer terrace hinge.
(IT) Montare la cerniera della terrazza skimmer.
(DE) Montieren Sie das Scharnier der Skimmerterrasse.
(NL) Monteer het terrasscharnier van de skimmer.

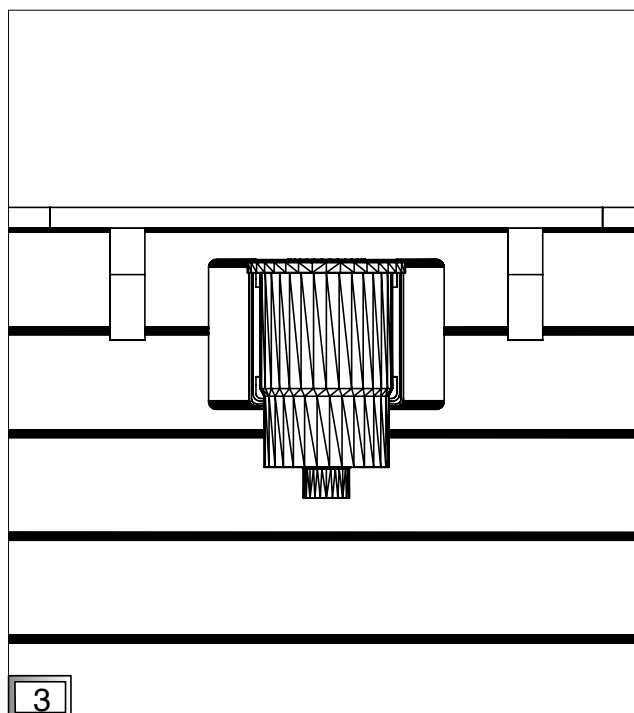
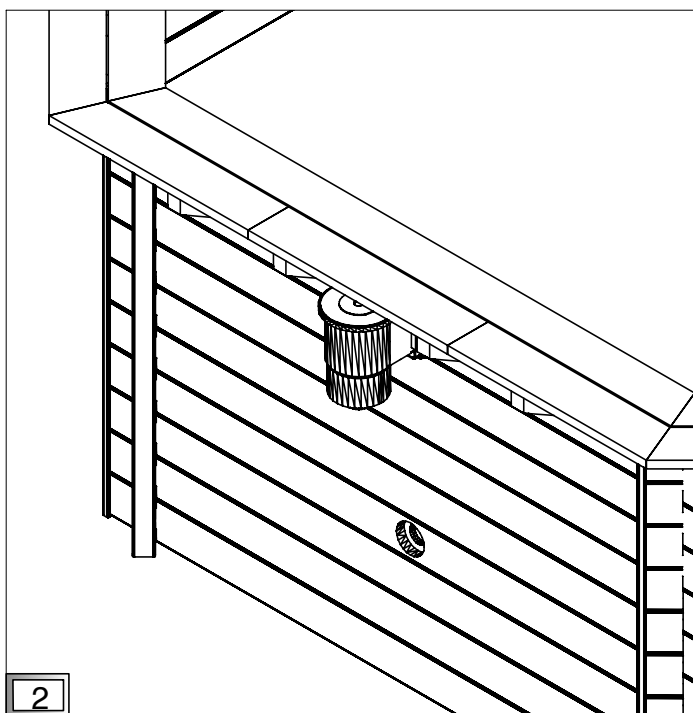
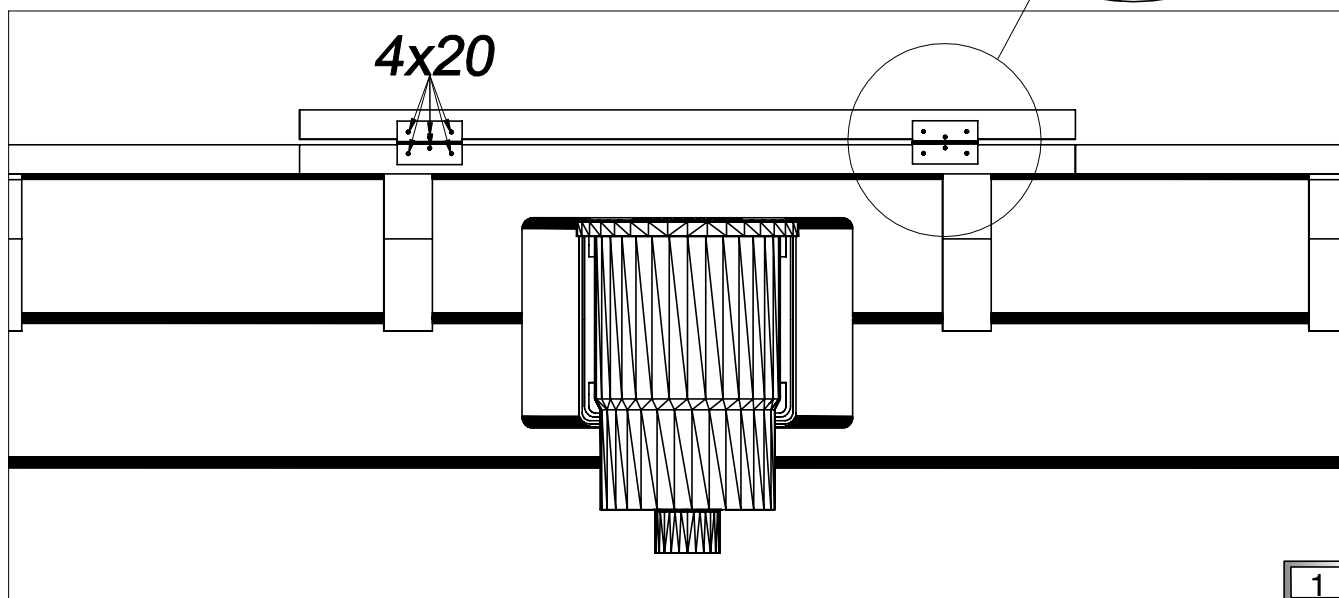
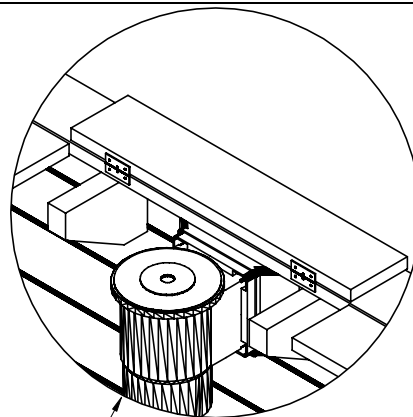
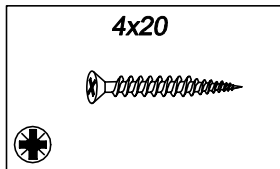
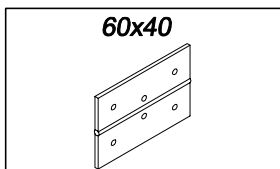

PL Struktura drewniana

GB Wooden structure

D Holzstruktur

FR La structure bois

IT Struttura in legno

NL Houten structuur



PL Montaż łącznika karo (19) od spodu desek tarasowych.

FR Le montage des jonctions (19) en dessous des margelles.

GB Installation of wooden connector (19) to the bottom of terrace boards.

IT Montaggio di raccordo (19) dal fondo delle tavole da terrazza.

D Montage vom Caro- Bindeglied (19) von der Unterseite des Terrassenholzes.

NL Installatie van de houten connector (19) aan de onderkant van de bovenranden.

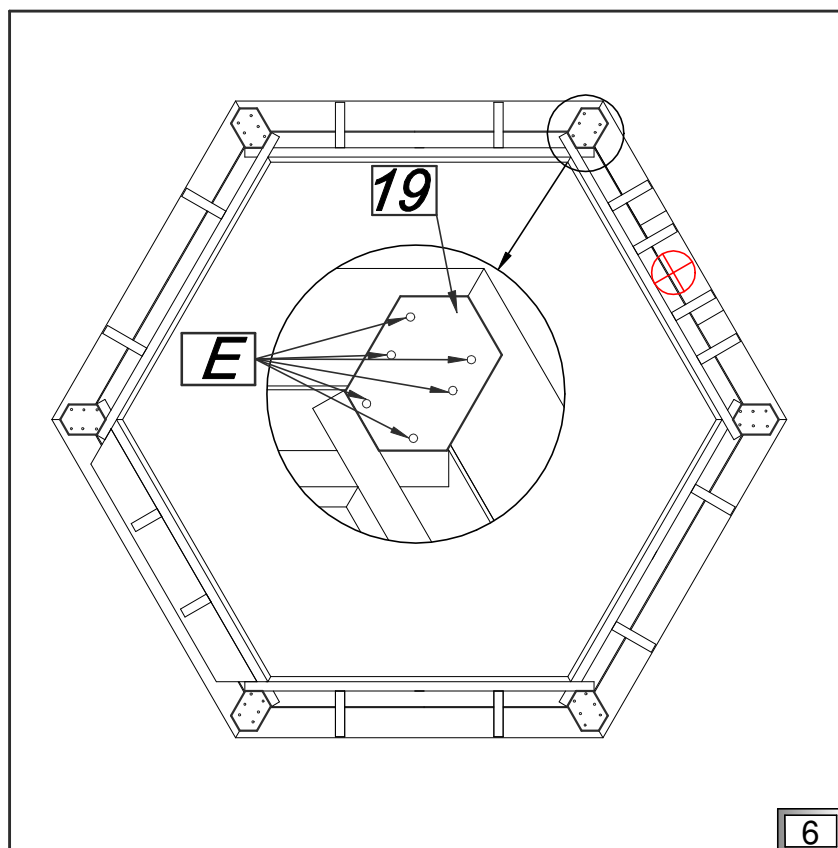
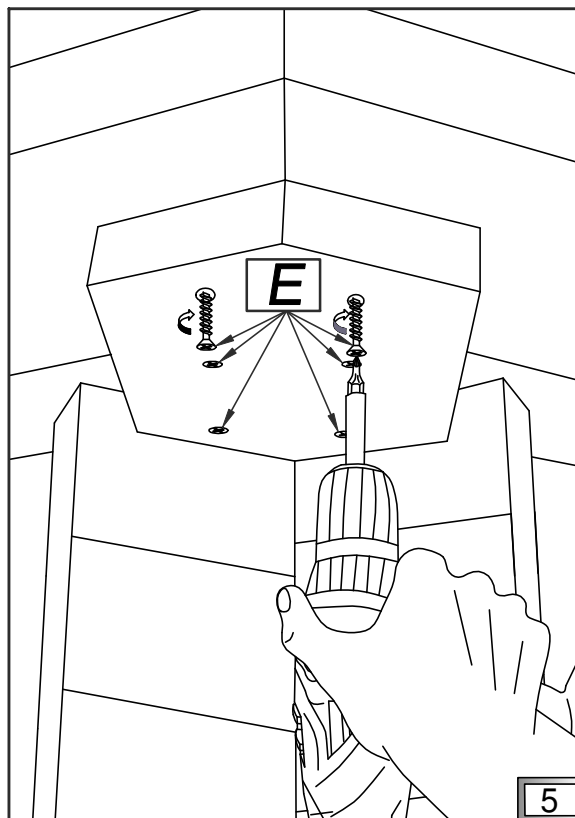
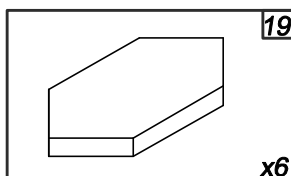
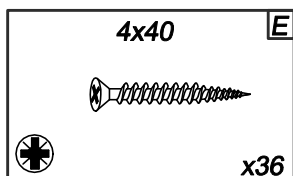
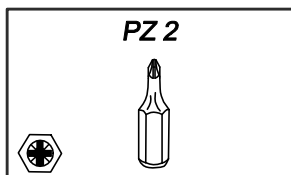
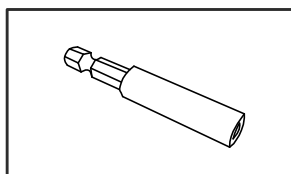
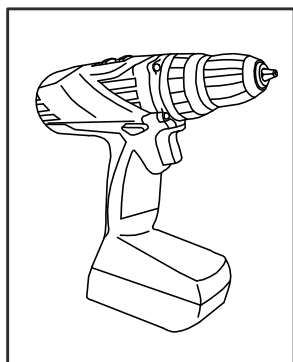

PL Widok od spodu tarasu.

FR La vue du dessous des margelles.

GB View from the bottom of terrace.

IT Vista in fondo della terrazza.

D Sicht vom unten der Terrasse.

NL Uitzicht van de onderkant van de bovenrand.

PL Schody drewniane

GB Wooden stairs

D Holztreppe

FR L'escalier bois

IT Scale di legno

NL Houten trap



- PL** Montaż schodów.
- FR** Le montage de l'escalier.
- GB** Installation of stairs.
- IT** Montaggio delle scale.
- D** Montage von Treppen.
- NL** Installatie van de houten trap.

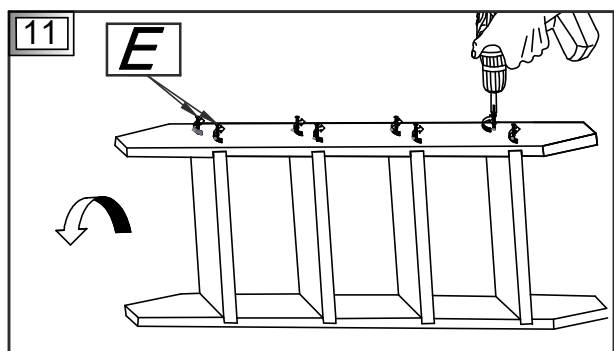
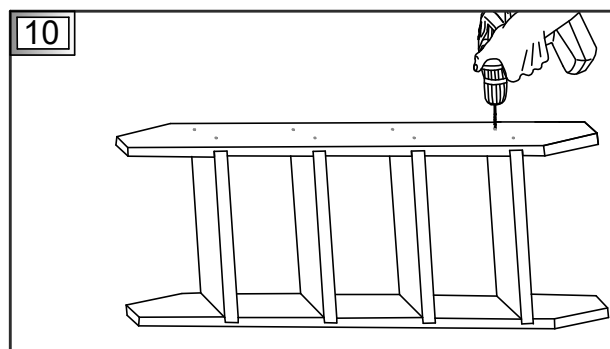
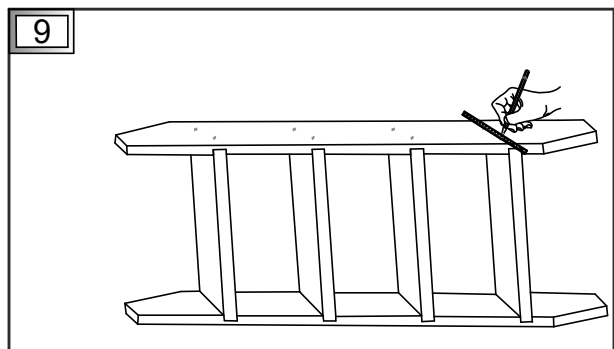
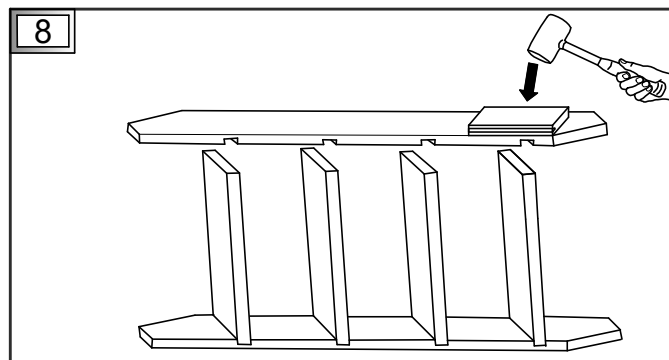
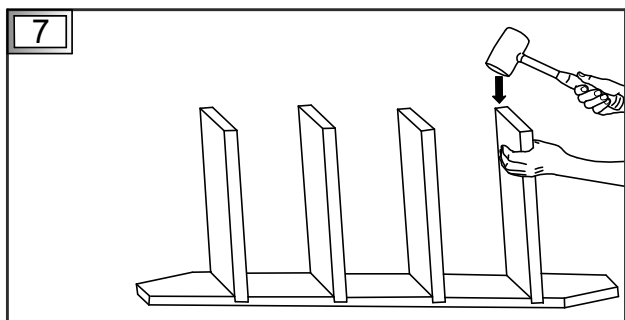
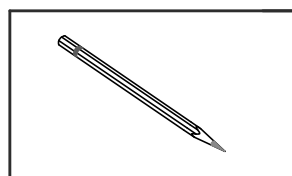
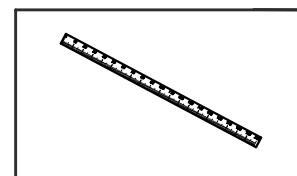
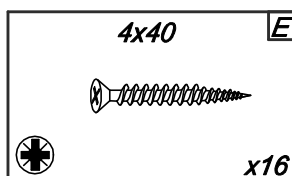
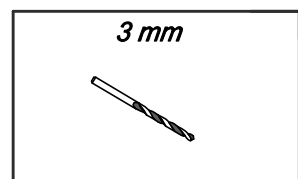
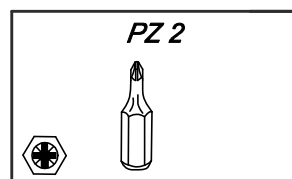
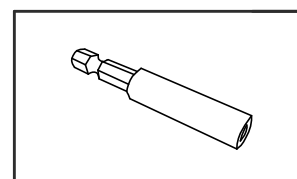
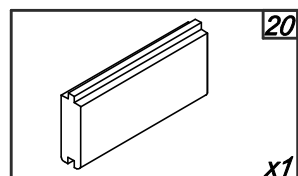
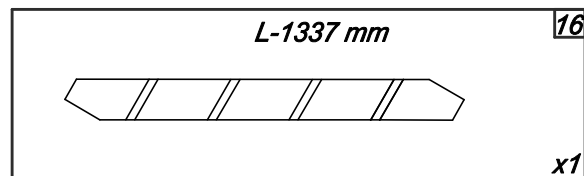
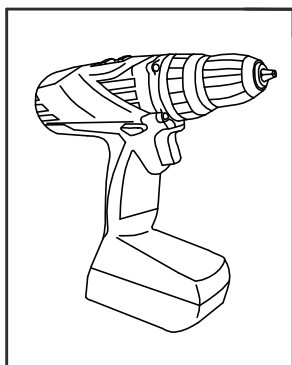
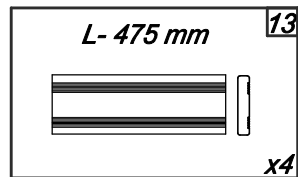
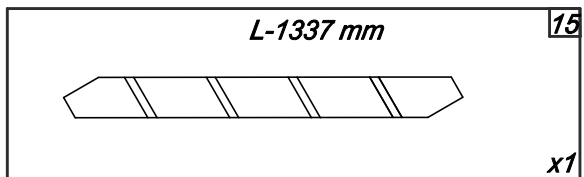
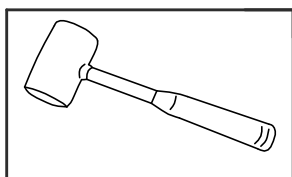

PL Schody drewniane

GB Wooden stairs

D Holztreppe

FR L'escalier bois

IT Scale di legno

NL Houten trap



PL Montaż zawieszki (B1, B2). Schody mocujemy na ścianie ze wspornikiem schodów (17).

FR Le montage des boucles et des gâches (B1, B2). Fixez l'escalier sur la paroi avec le renfort d'escalier (17).

GB Installation of tag and hook kit (B1, B2). Stairs are mounted on the wall with stairs support (17).

IT Montaggio del manico (B1, B2). Le scale sono fissate al muro con uno sbalzo di scale (17).

D Montage vom Gehänge (B1, B2). Die Treppe ist an die Wand mit Treppenstützen (17) zu montieren.

NL Installatie van het inhaak systeem (B1,B2) trap wordt aan de bovenrand gemonteerd (17).

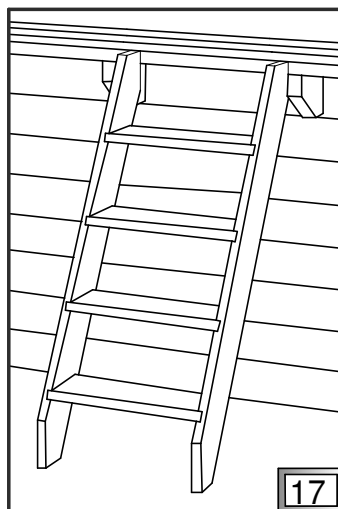
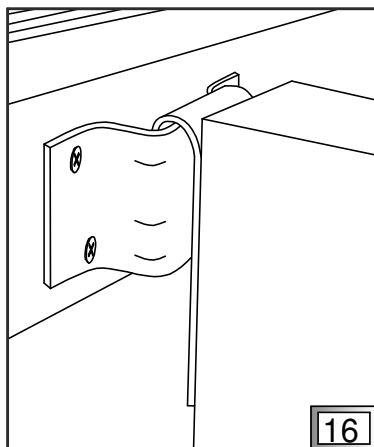
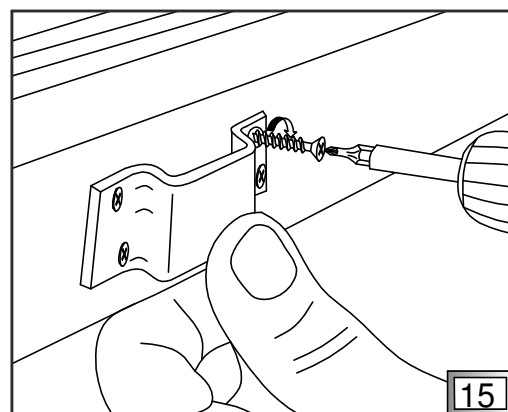
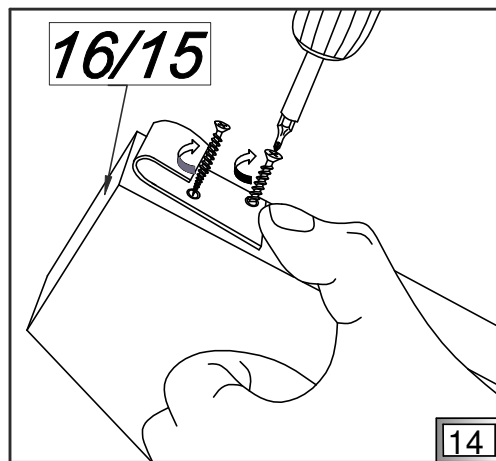
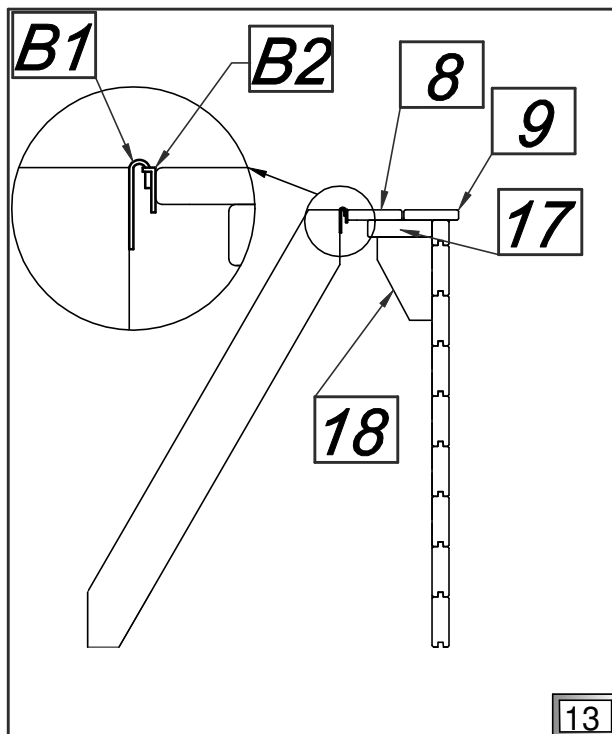
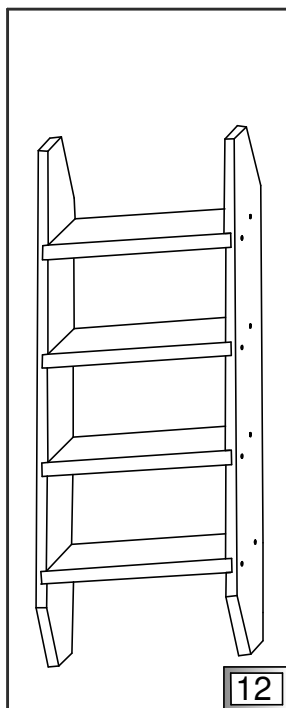
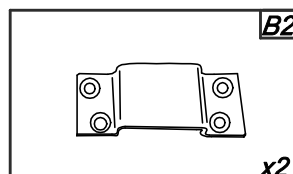
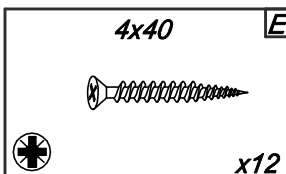
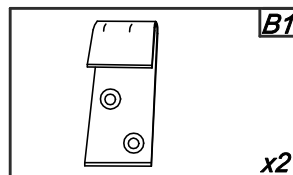
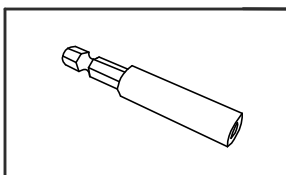
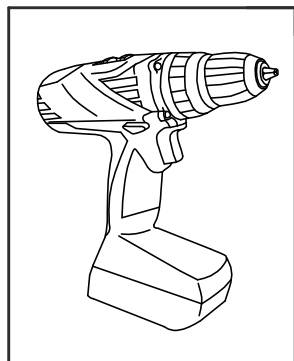

PL Maskownice

GB Corners covers

D Abdeckungen

FR Les caches

IT Mascherini

NL Afdekkappen



PL Montaż maskownic (Y) do desek tarasowych.

FR Le montage des caches (Y) pour les margelles.

GB Mounting covers (Y) for corners of terrace boards.

IT Montaggio di mascherini (Y) per le tavole da terrazza.

D Montage der Abdeckungen (Y) ans Terrassenholz.

NL Roest vrij afdekkappen (Y) voor de hoeken van de bovenrand.

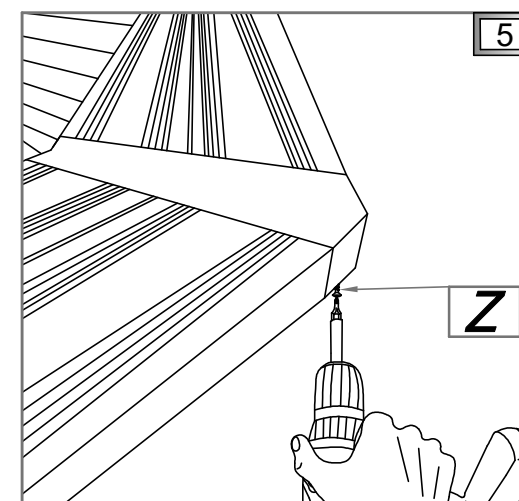
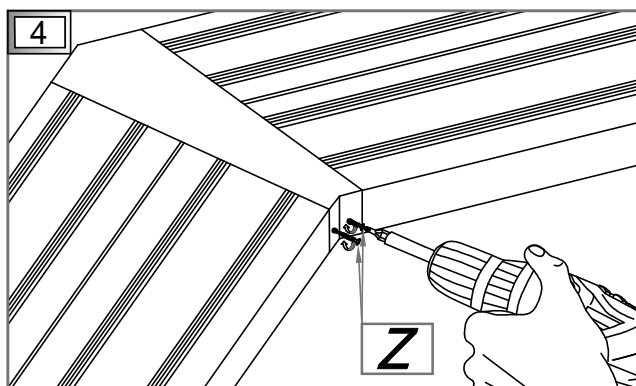
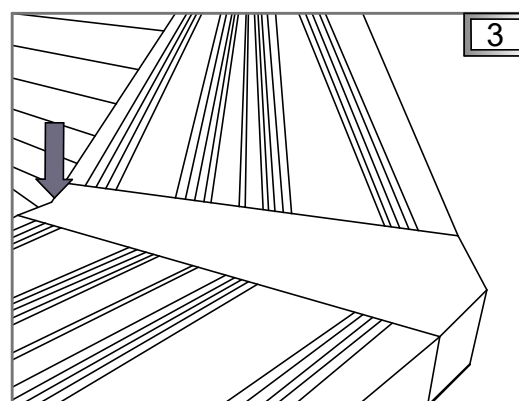
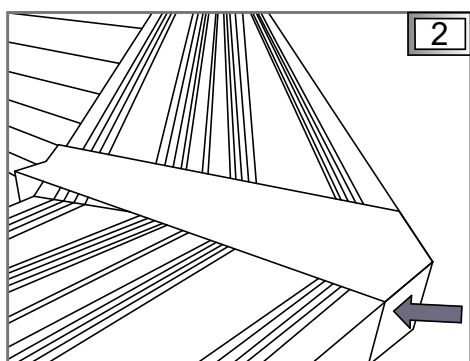
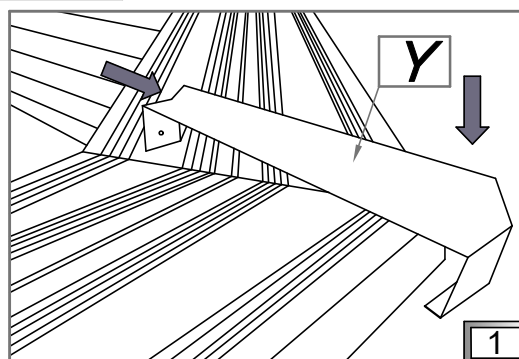
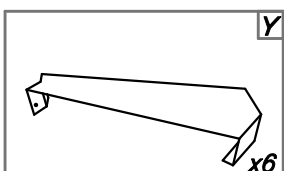
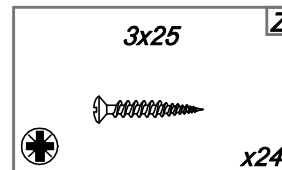
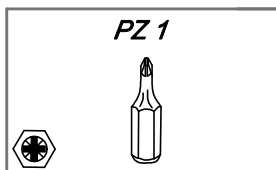
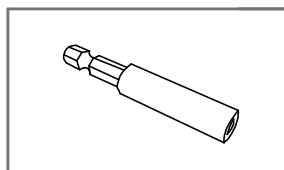
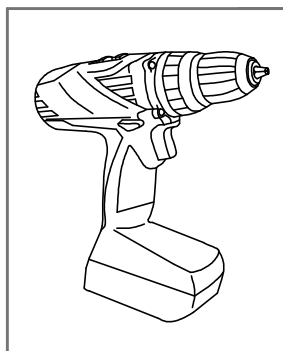

PL Widok od spodu tarasu.

FR La vue du dessous des margelles.

GB View from the bottom of terrace.

IT Vista in fondo della terrazza.

D Sicht vom unten der Terrasse.

NL Uitzicht van de onderkant van de bovenrand.

